

# 712 PCS

Light Brown

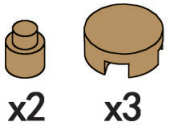

Light Grey

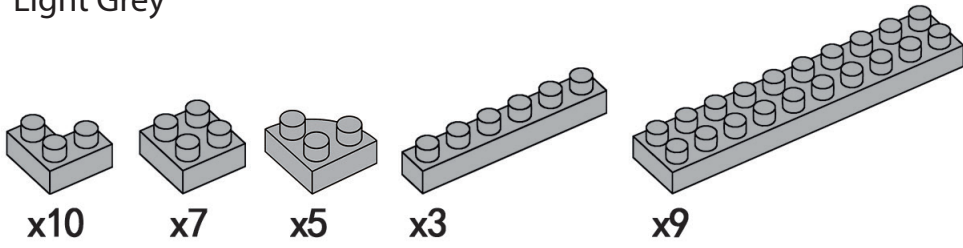

Red



Dark Green



Dark Grey

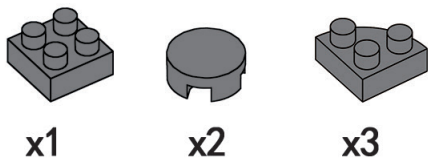

Light Green

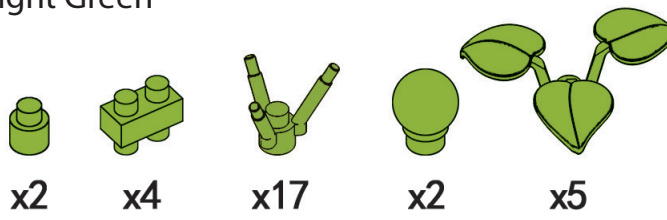

Green

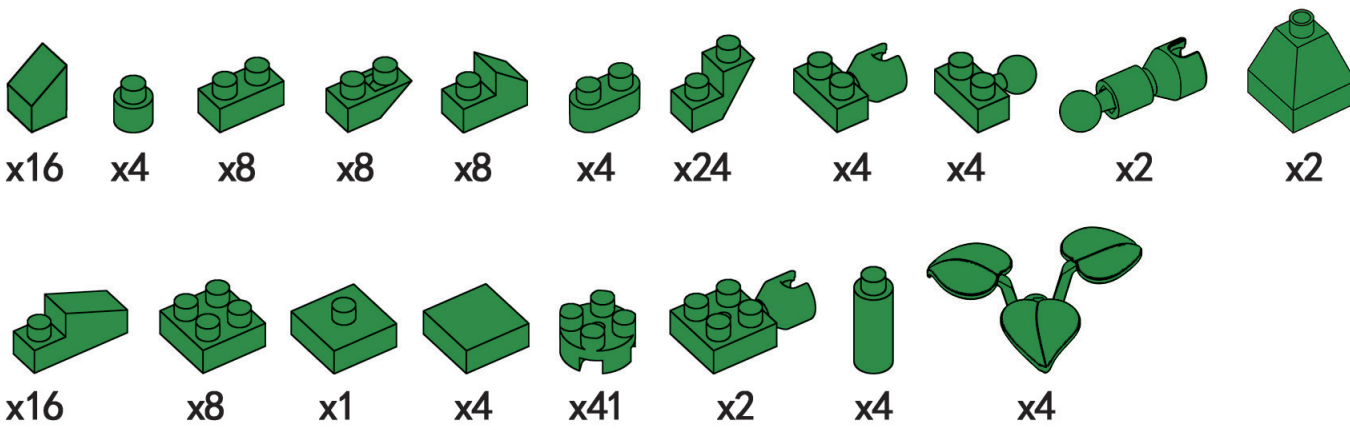

Pink

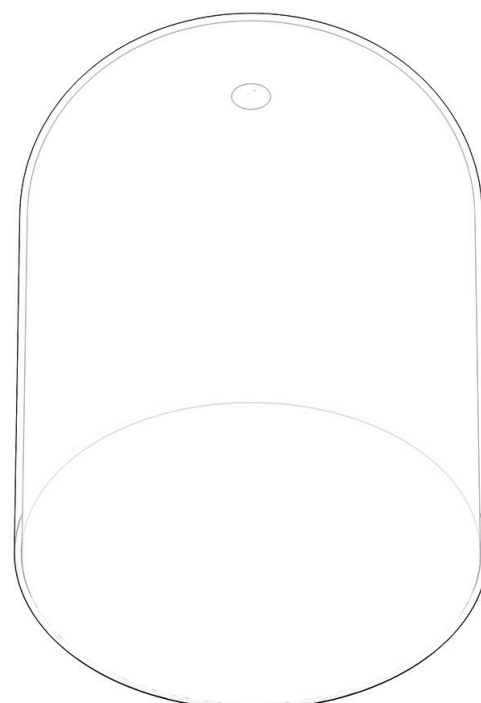
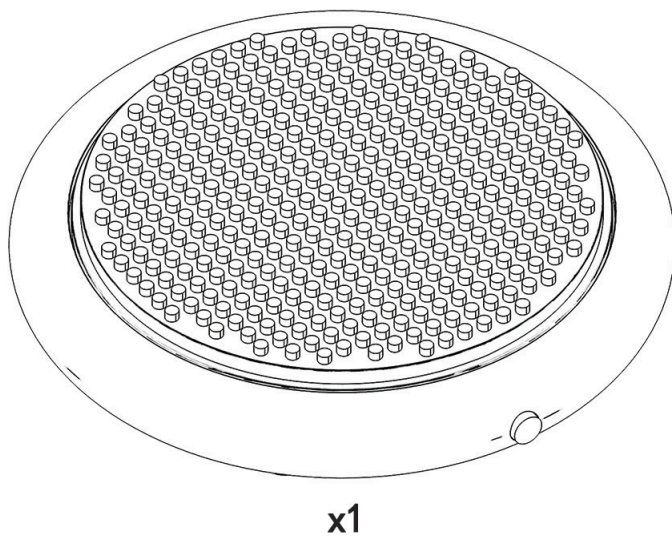
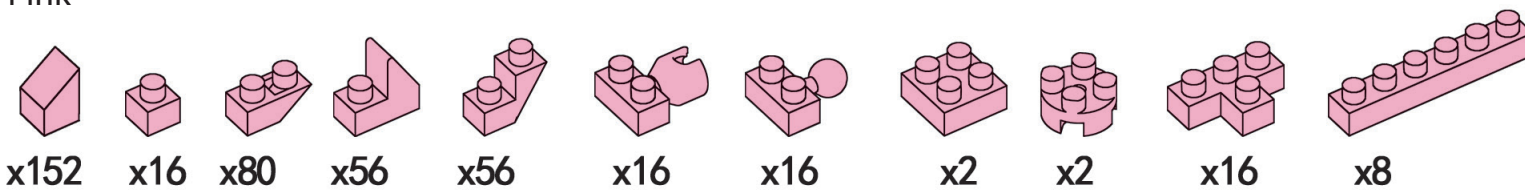

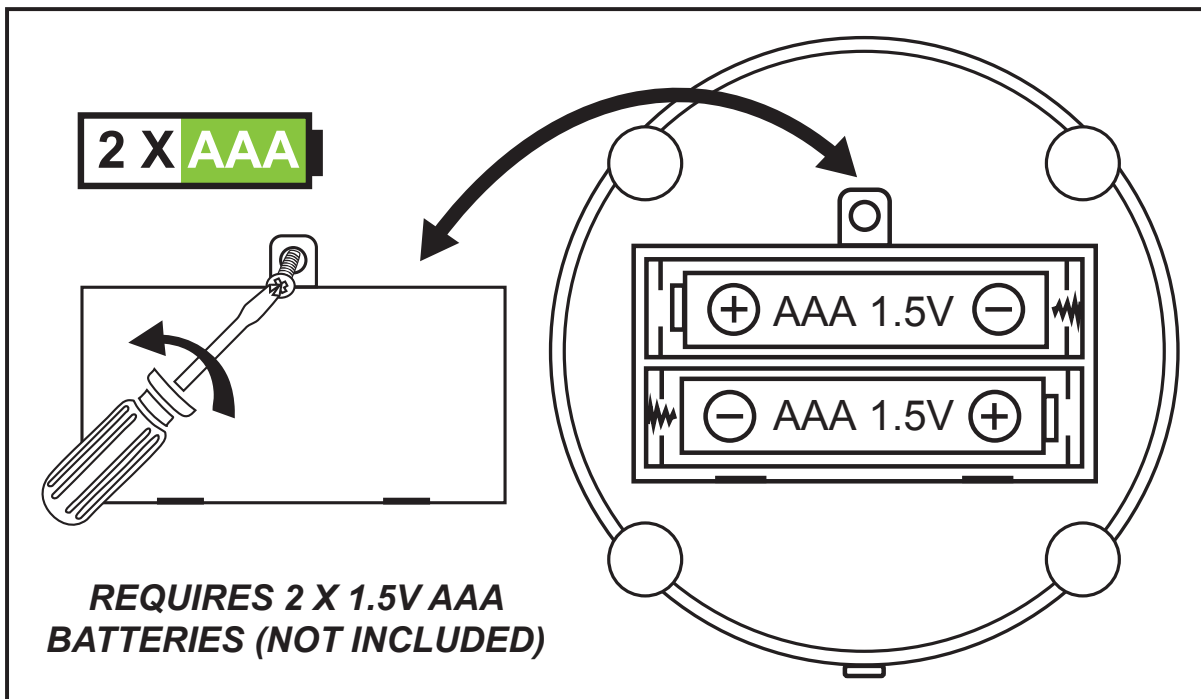

**WARNING!** BATTERIES ARE TO BE INSERTED WITH THE CORRECT POLARITY (+ AND -). DO NOT MIX DIFFERENT TYPES OF BATTERIES OR NEW AND USED BATTERIES. NON-RECHARGEABLE BATTERIES ARE NOT TO BE RECHARGED. RECHARGEABLE BATTERIES SHOULD BE CHARGED UNDER ADULT SUPERVISION. RECHARGEABLE BATTERIES ARE TO BE REMOVED FROM THE TOY BEFORE BEING CHARGED. THE SUPPLY TERMINALS ARE NOT TO BE SHORT-CIRCUITED. REMOVE BATTERIES FROM THE TOY WHEN NOT IN USE FOR EXTENDED TIME OR WHEN BATTERIES BECOME EXHAUSTED. BATTERY INSTALLATION BY AN ADULT IS REQUIRED. DISPOSE OF BATTERIES RESPONSIBLY. DO NOT DISPOSE OF IN FIRE. DO NOT LET CHILDREN UNDER 8 YEARS OLD CHANGE BATTERIES. ADULT SUPERVISION IS RECOMMENDED FOR CHILDREN BETWEEN 8-14 YEARS. FAILURE TO FOLLOW THESE INSTRUCTIONS MAY CAUSE THE BATTERIES TO EXPLODE OR LEAK.

**WARNING! CHOKING HAZARD**  
SMALL PARTS. NOT SUITABLE FOR CHILDREN UNDER 3 YEARS

**WARNING!** FOR SAFETY REASONS, REMOVE ALL PACKAGING, TAGS, LABELS AND PLASTIC FASTENERS BEFORE GIVING THIS TO A CHILD.

**CAUTION:** AVOID CONTACT WITH LIQUIDS AND MOISTURE.

**ADULT ASSISTANCE IS RECOMMENDED.**

**PRODUCT MAY VARY SLIGHTLY FROM IMAGE SHOWN.**

**PLEASE KEEP THE PACKAGING FOR FUTURE REFERENCE.**

**MADE IN CHINA**

**6029213**



BUILD, DESIGN, DISPLAY

**Helpful Tips Before You Start!**

1. Before you begin building, sort the blocks by shape. This makes it easier to find the right pieces.
2. After Step 1, if you see blocks in light blue, that means they were already built in the last step. Just keep building on top of them!

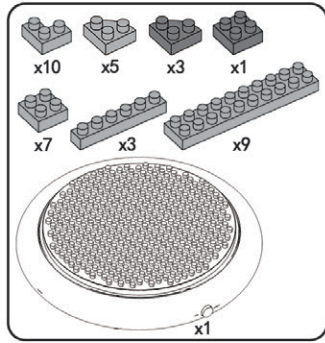

**1.**

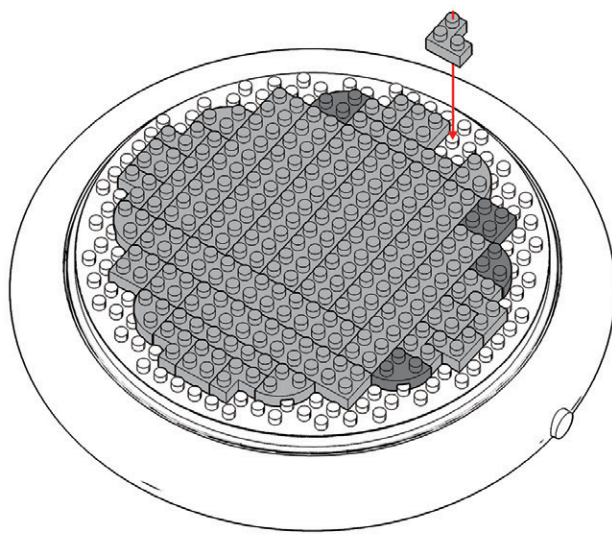

**2.**

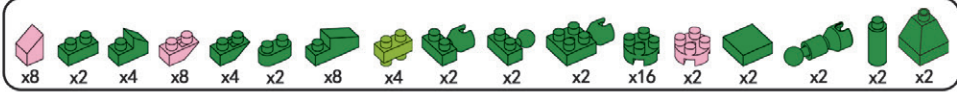
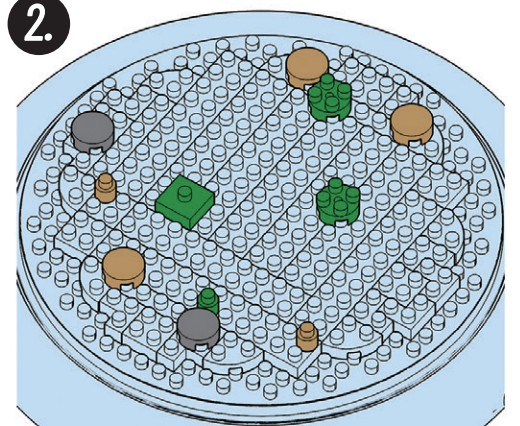

**3.**

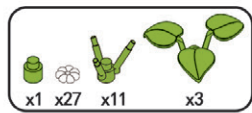
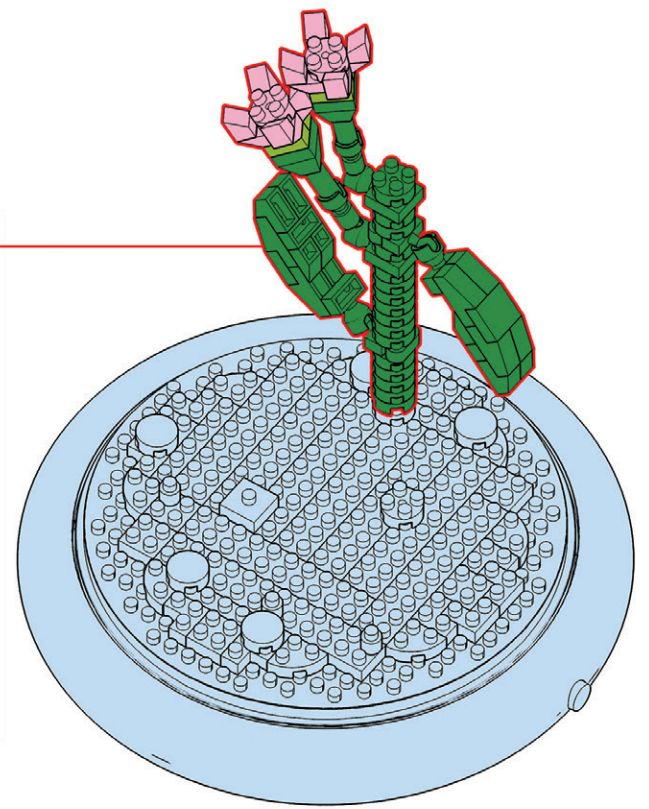
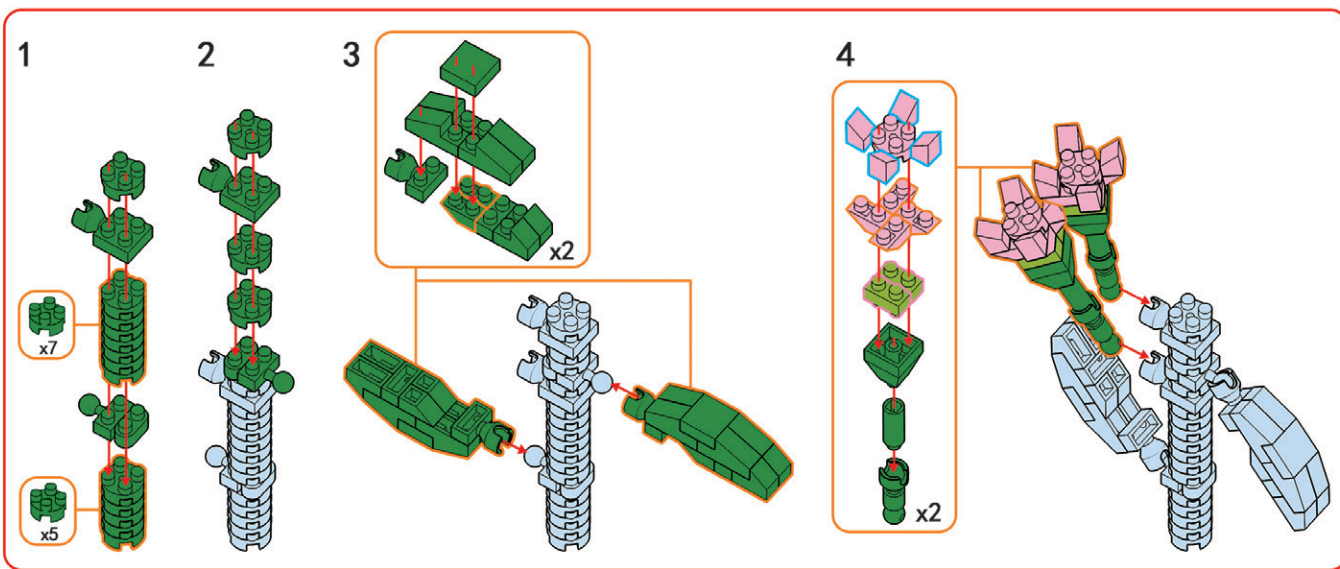

**4.**

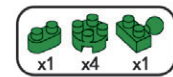
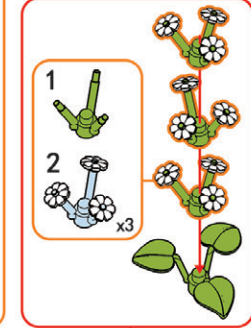
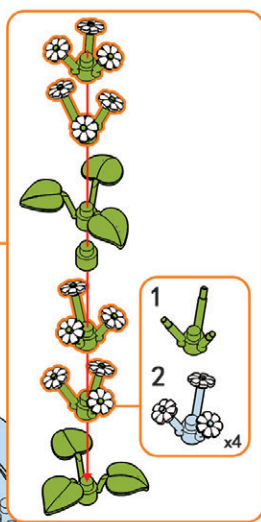
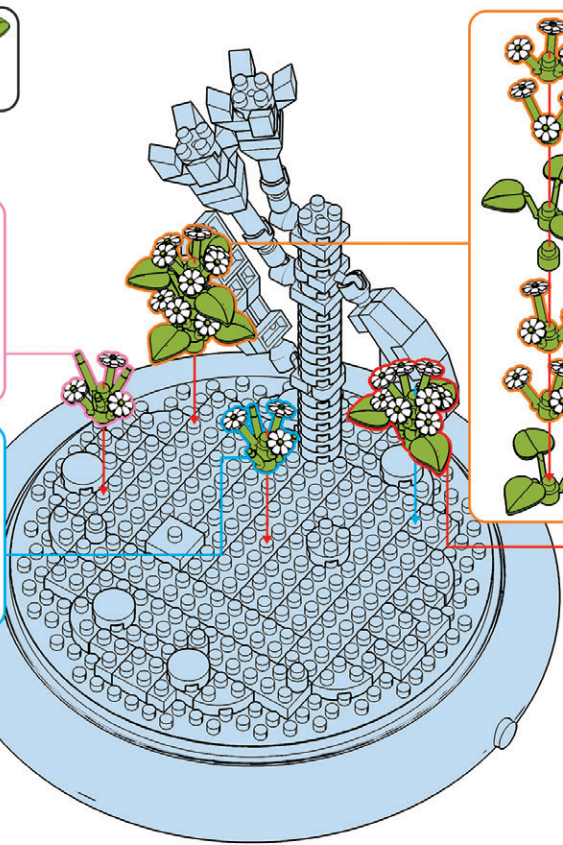
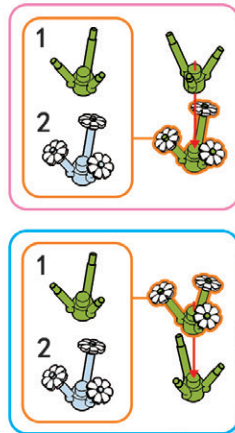

**5.**

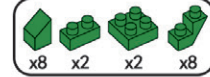

**6.**

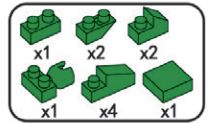
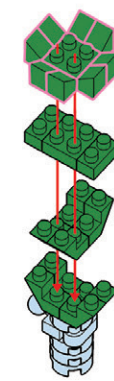

**7.**

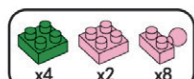
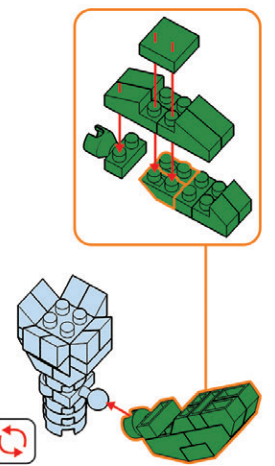

**8.**

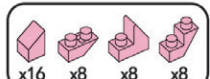
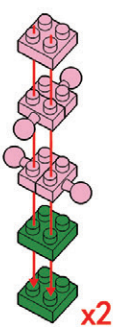

**9.**

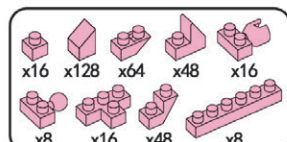
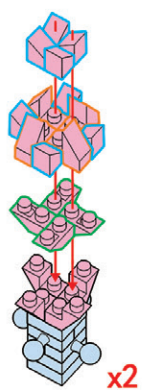

**10.**

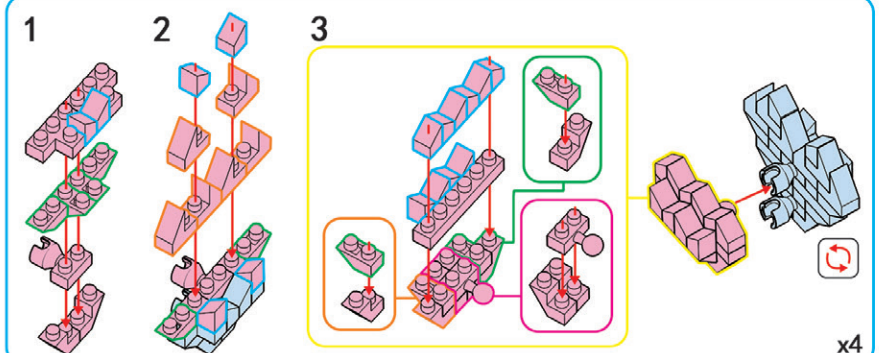
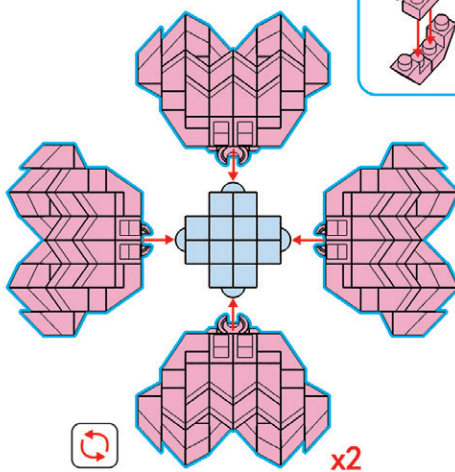

x4

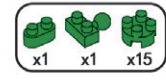
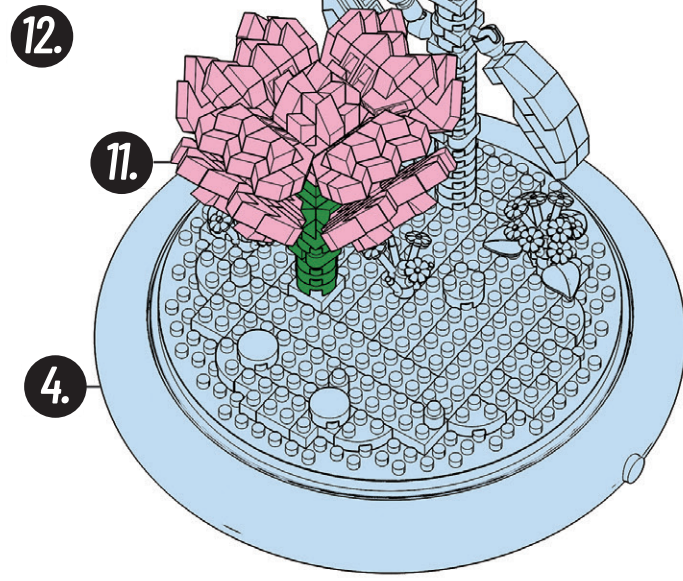
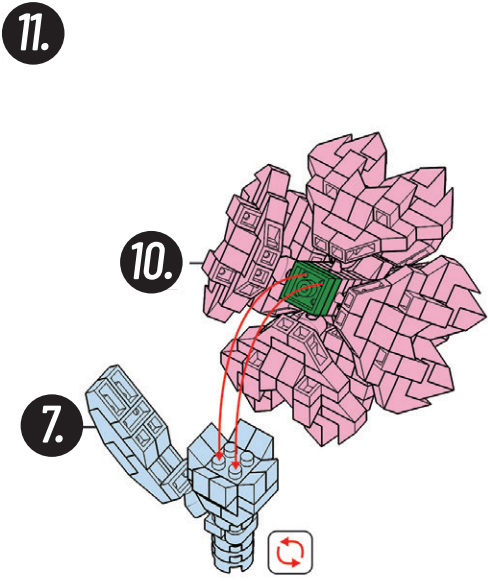

**13.**

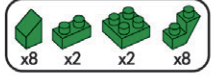
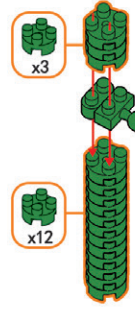

**14.**

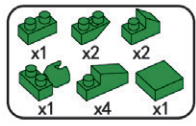
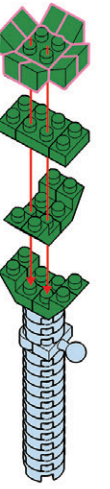

**15.**

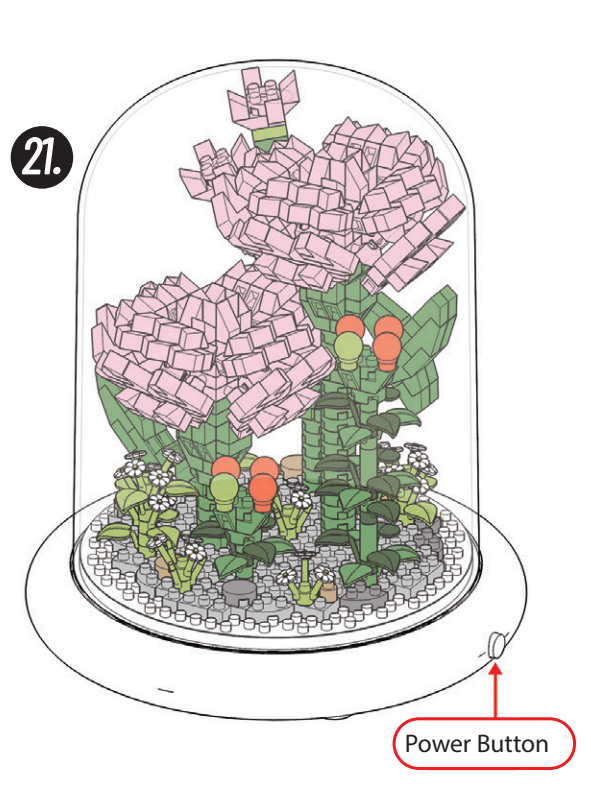
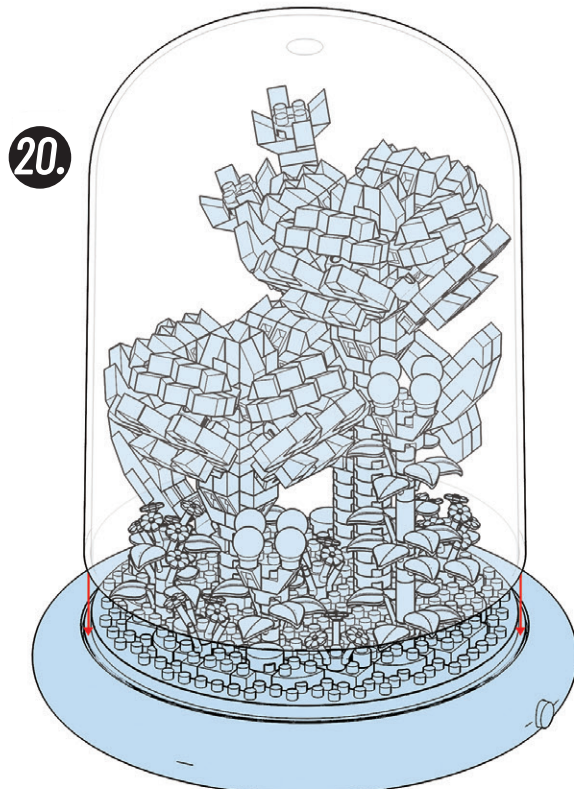
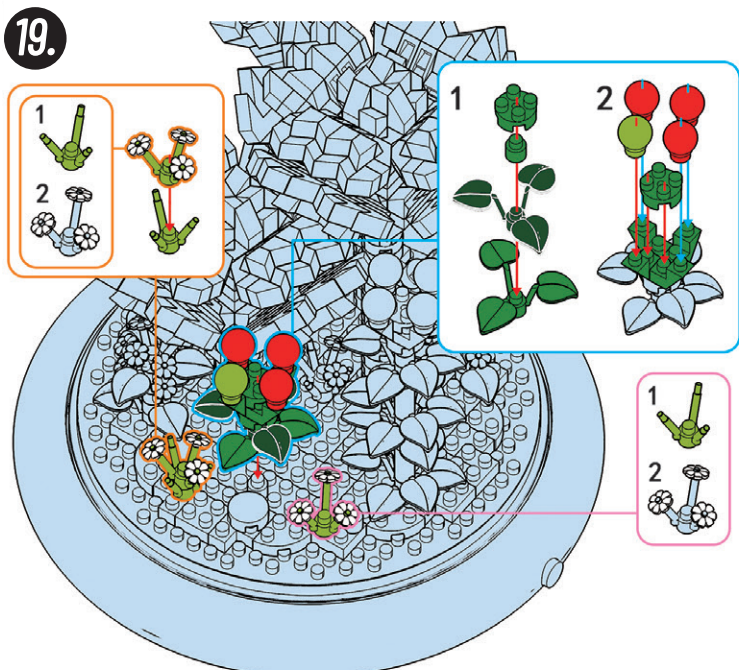
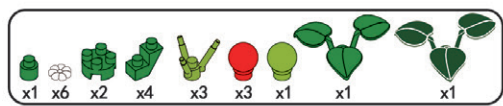
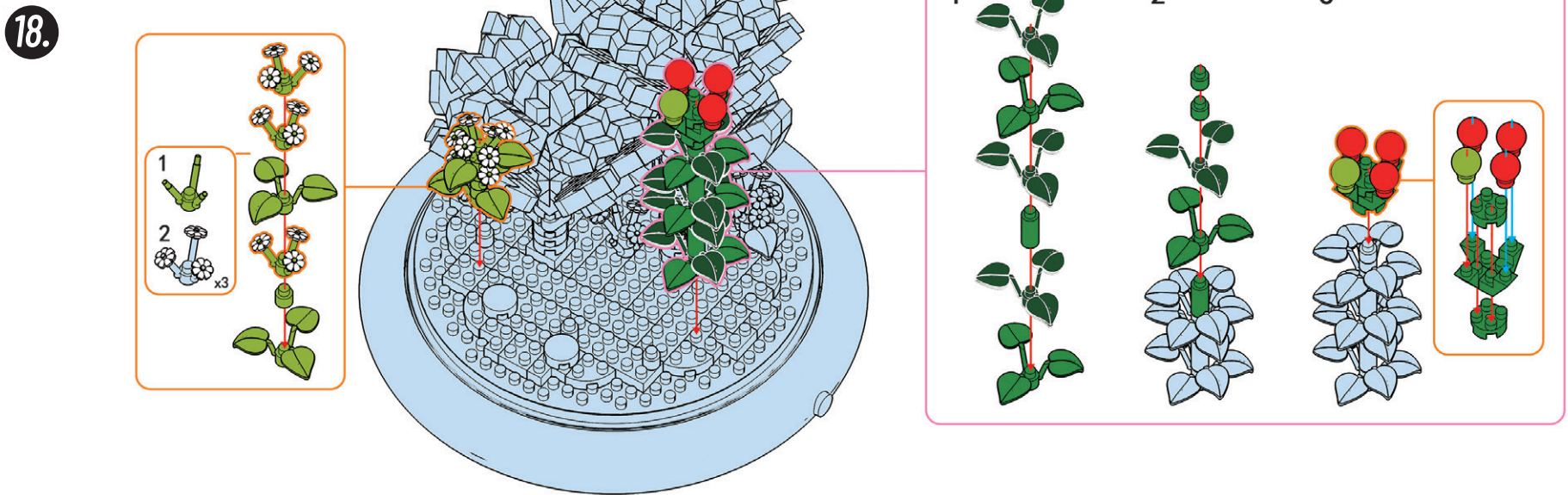
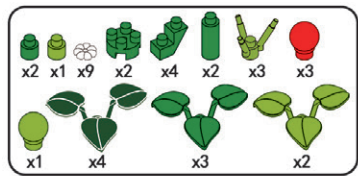
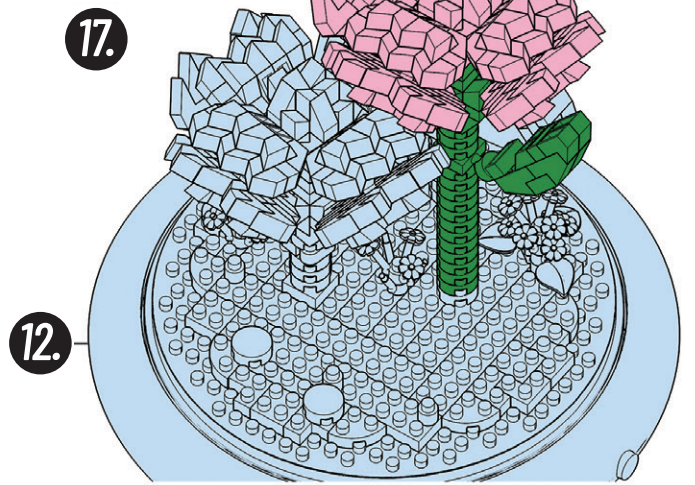
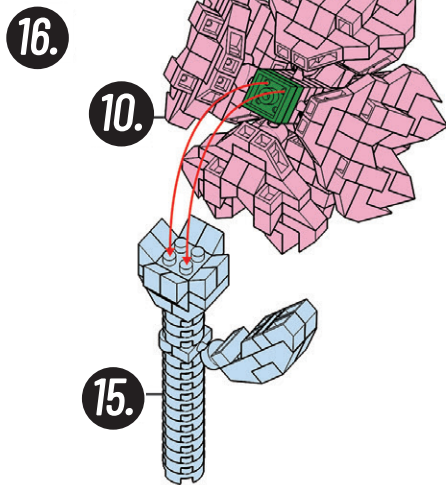
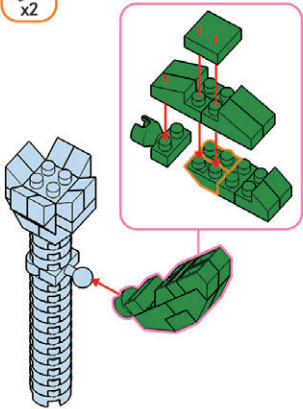

Power Button