

Helpful Tips Before You Start!

1. Before you begin building, sort the blocks by shape. This makes it easier to find the right pieces.
2. After Step 1, if you see blocks in light blue, that means they were already built in the last step. Just keep building on top of them!

Parts List
453 PCS

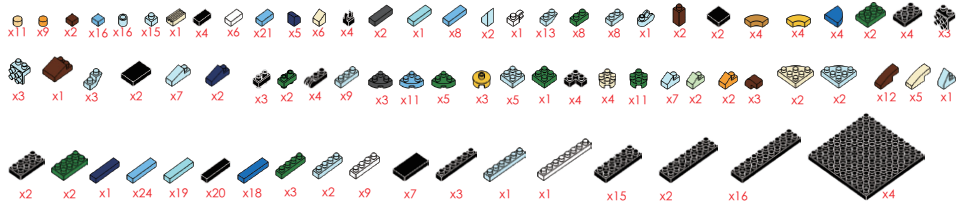

1.

2.

3.

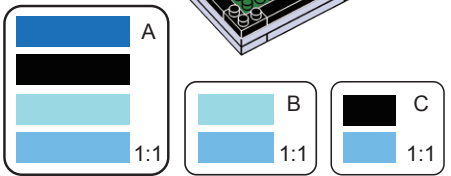
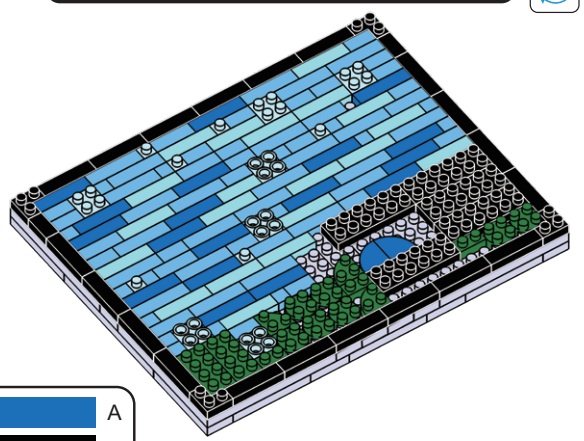
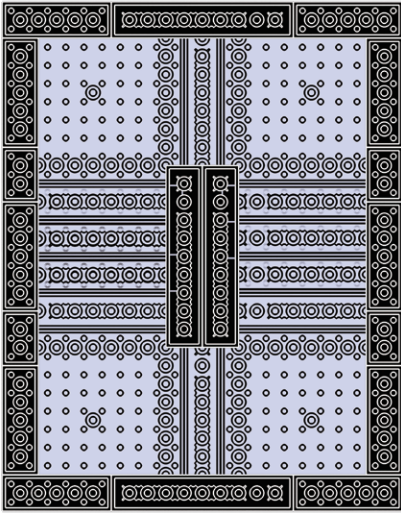
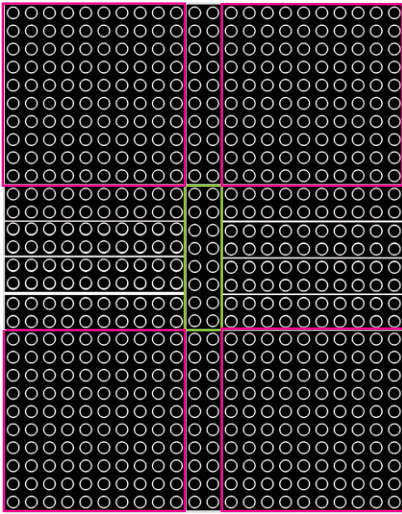

4.

5.

6.

7.

8.

9.

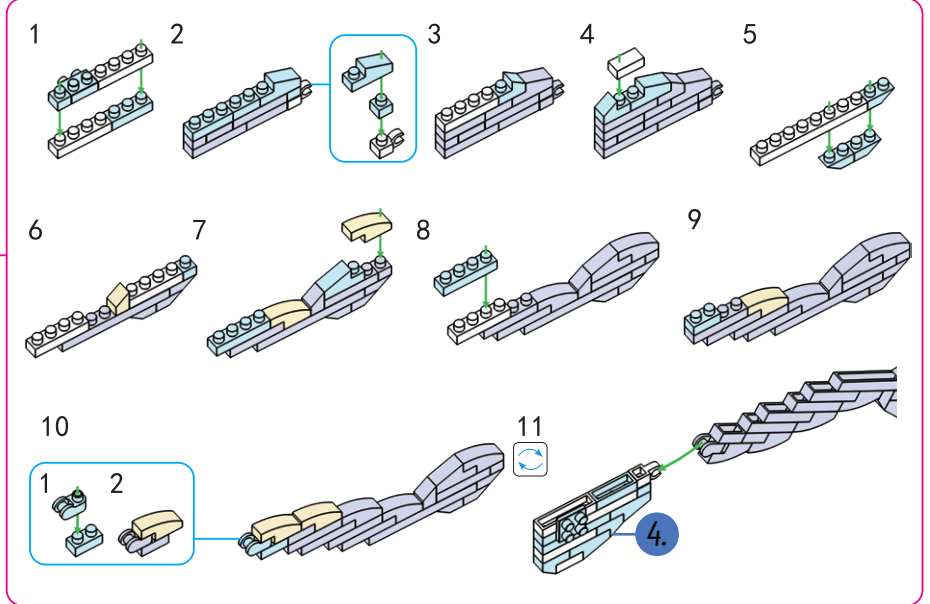
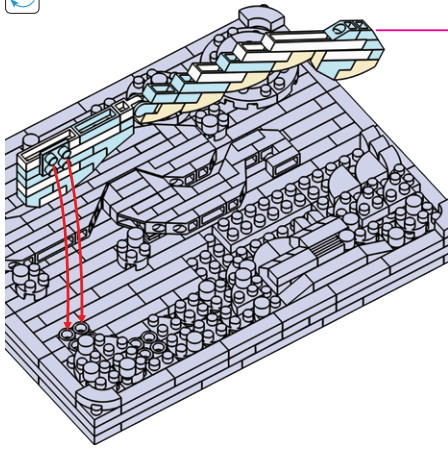
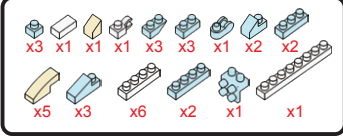

10.

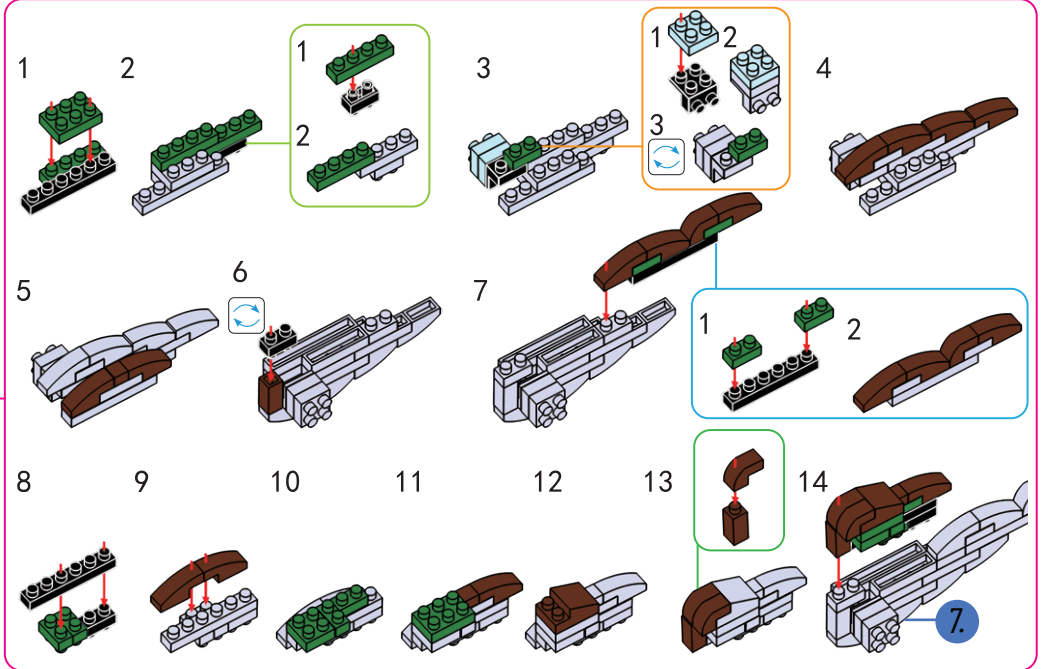
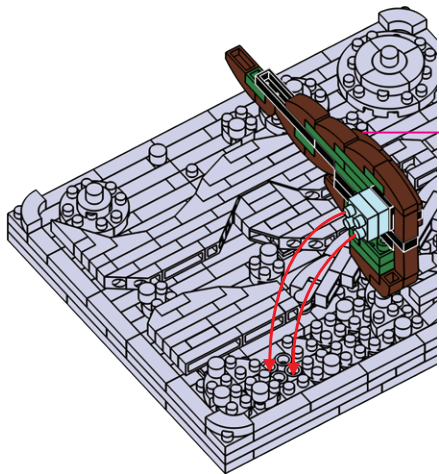
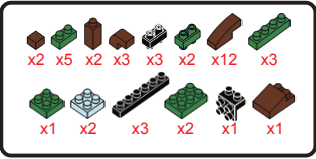

11.

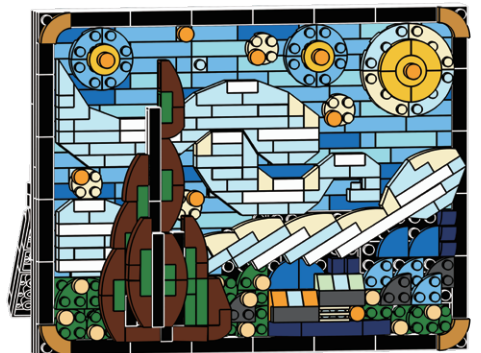
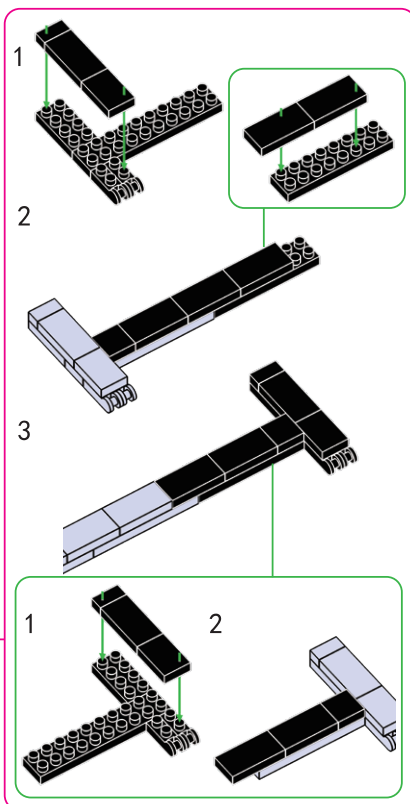
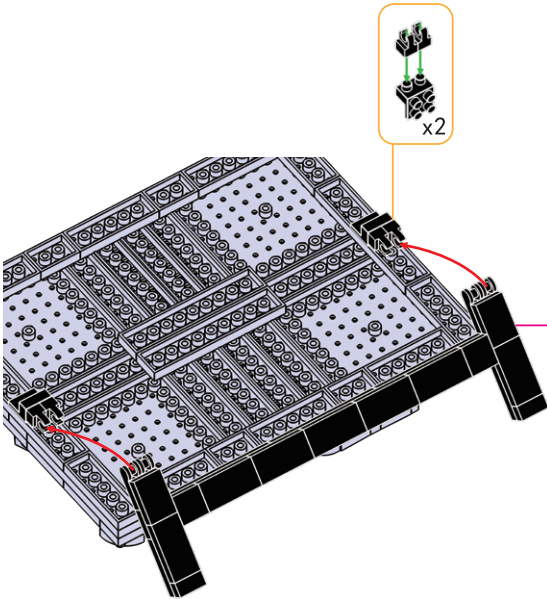
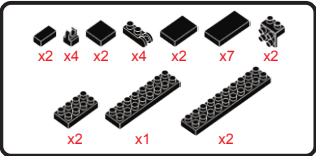

Display your finished build and enjoy your creation!