

BUILD, DESIGN, DISPLAY

Parts List
555 PCS

Blue

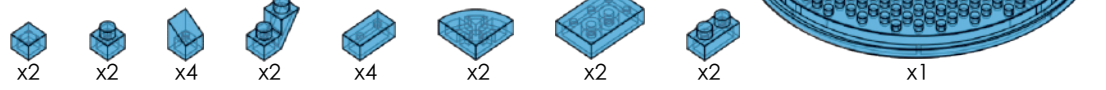

Stickers



Plug



Bottle

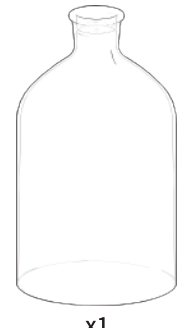

Black

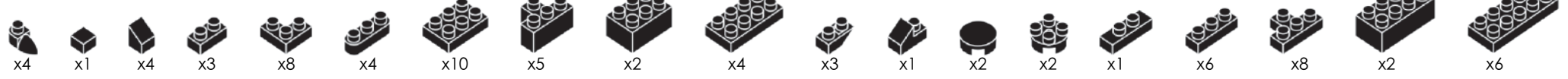

Dark Grey

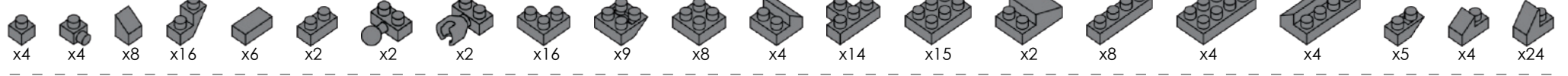

Light Grey

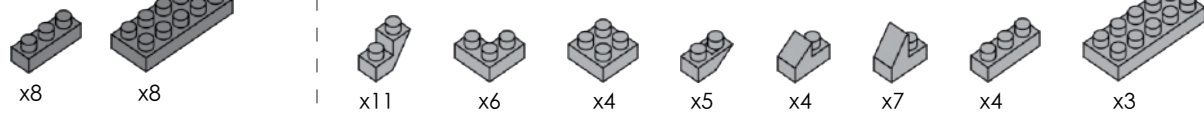

White

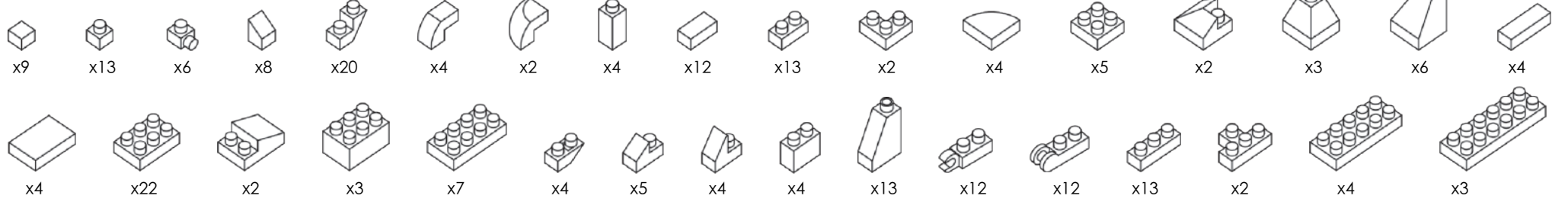

Helpful Tips Before You Start!

1. Before you begin building, sort the blocks by color. This makes it easier to find the right pieces.
2. After Step 1, if you see blocks in pale blue, that means they were already built in the last step. Just keep building on top of them!

1.

2.

3.

4.

5.

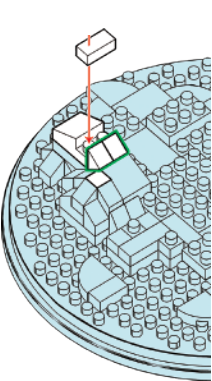
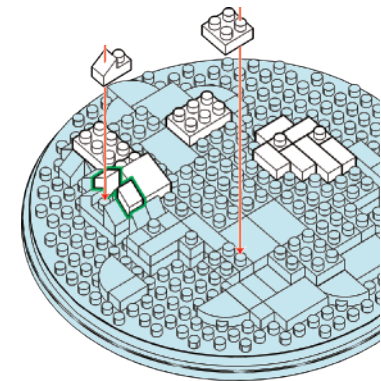
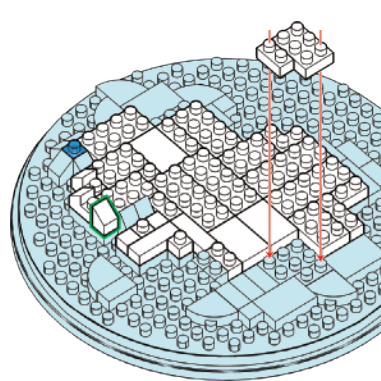
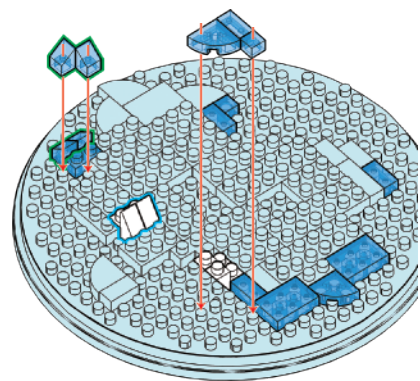
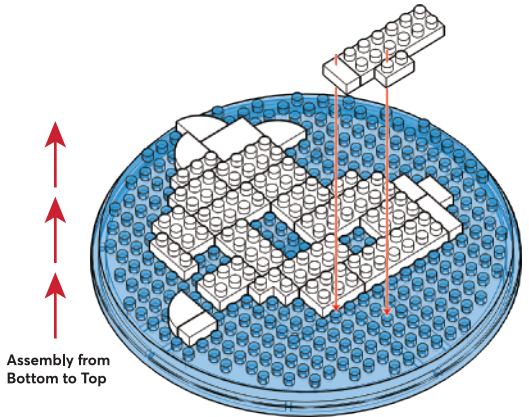

6.1.

6.2.

6.3.

6.4.

6.5.

6.6.

6.7.

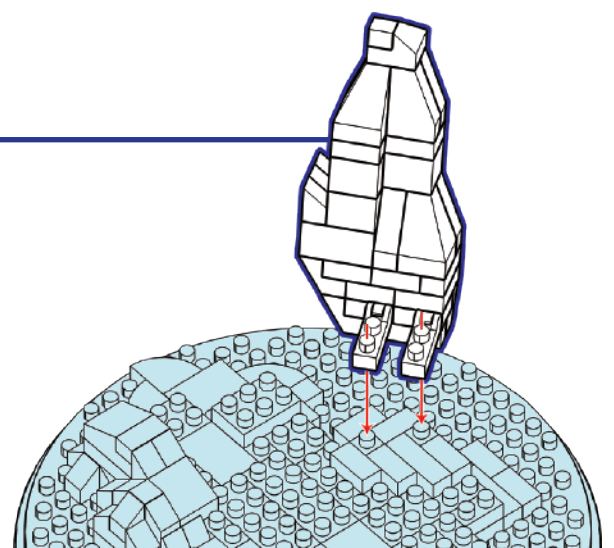
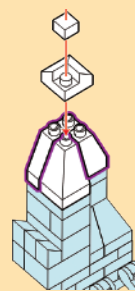
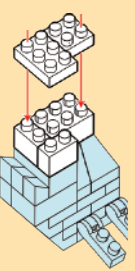
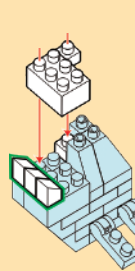
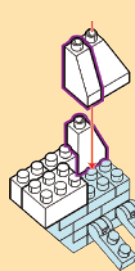

WARNING:
CHOKING HAZARD— Small Parts.
Not for children under 3 years.

WARNING: FOR SAFETY REASONS, REMOVE ALL PACKAGING,
TAGS, LABELS AND PLASTIC FASTENERS BEFORE GIVING
THIS TOY TO YOUR CHILD.

ADULT ASSISTANCE IS RECOMMENDED.
PRODUCT MAY VARY SLIGHTLY FROM IMAGE SHOWN.
PLEASE KEEP PACKAGING FOR FUTURE REFERENCE.



7.

1. x1 x3 x2 x2 x1

2. x1 x1 x1 x2

3. x1 x1

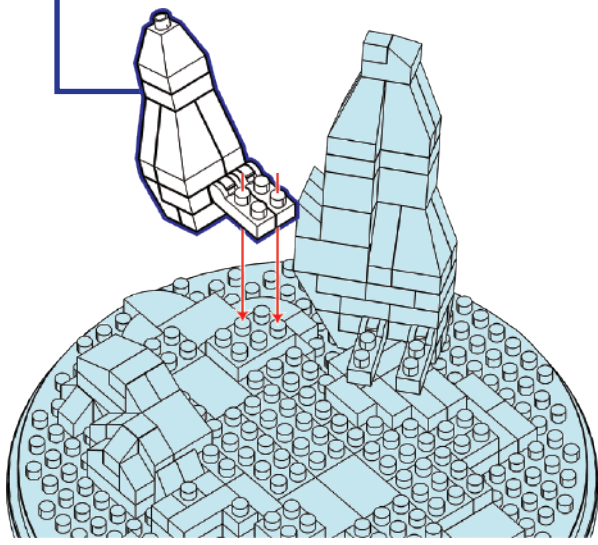

8.

1. x1 x1 x1 x1 x2

2. x1 x1 x2 x1 x1 x1 x1

3. x1 x1

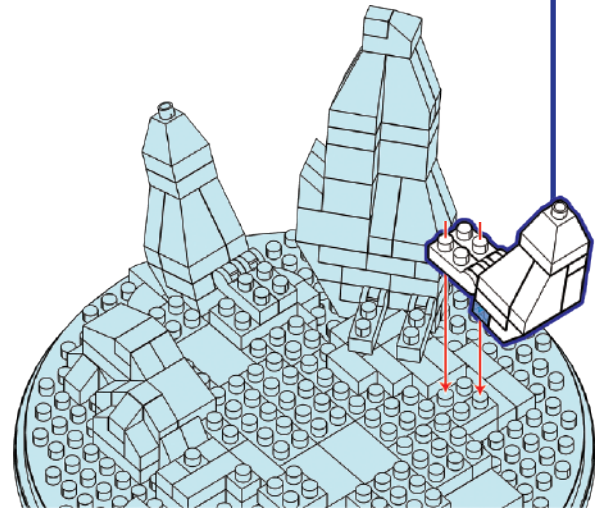

9.

1. x3 x1 x2 x2 x1

2. x2 x1 x1

3. x1 x1

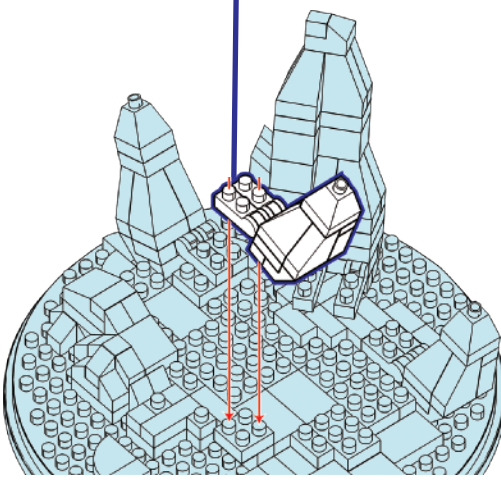

10.

1. x2 x2 x1 x3 x1

2. x2 x1 x1

3. x1 x1 x1

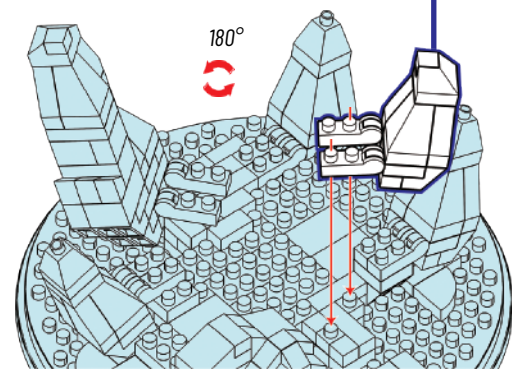

11.

x2 x7 x3 x6

x1 x5 x2 x2

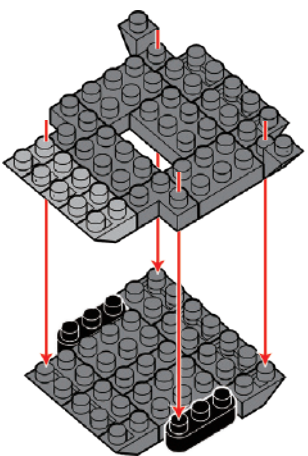

12.

x2 x10 x3 x2

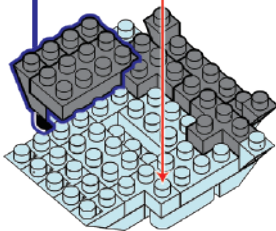

13.

x2 x2 x3 x5

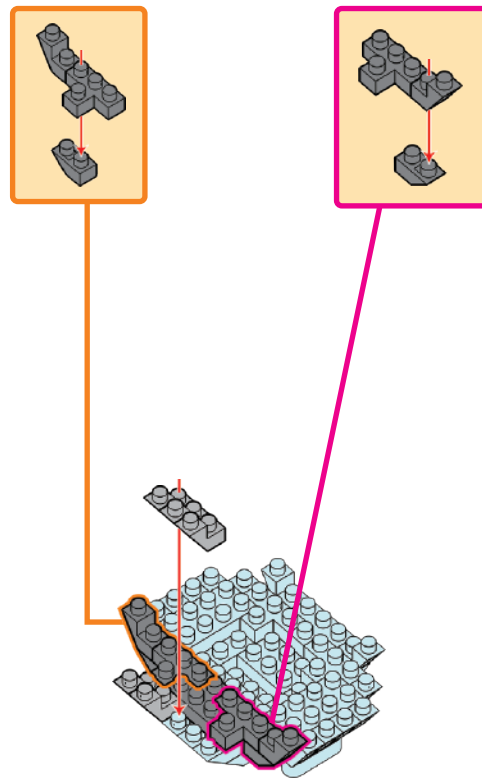

14.

x2 x2 x6 x2 x1

x2 x1

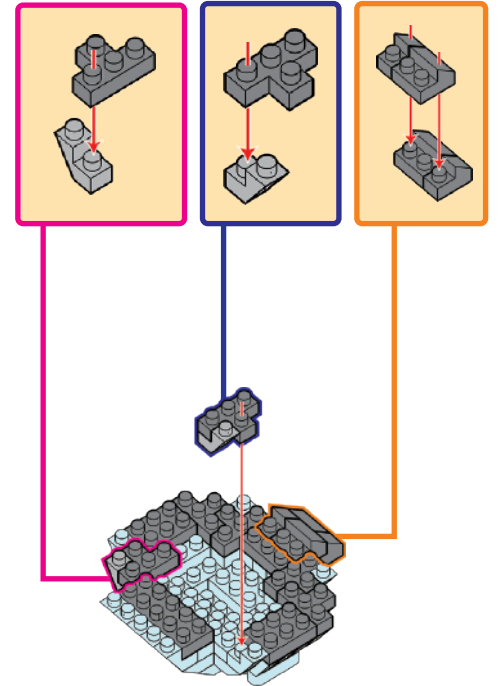

WARNING:
CHOKING HAZARD— Small Parts.
Not for children under 3 years.

WARNING: FOR SAFETY REASONS, REMOVE ALL PACKAGING,
TAGS, LABELS AND PLASTIC FASTENERS BEFORE GIVING
THIS TOY TO YOUR CHILD.

ADULT ASSISTANCE IS RECOMMENDED.
PRODUCT MAY VARY SLIGHTLY FROM IMAGE SHOWN.
PLEASE KEEP PACKAGING FOR FUTURE REFERENCE.



BUILD, DESIGN, DISPLAY

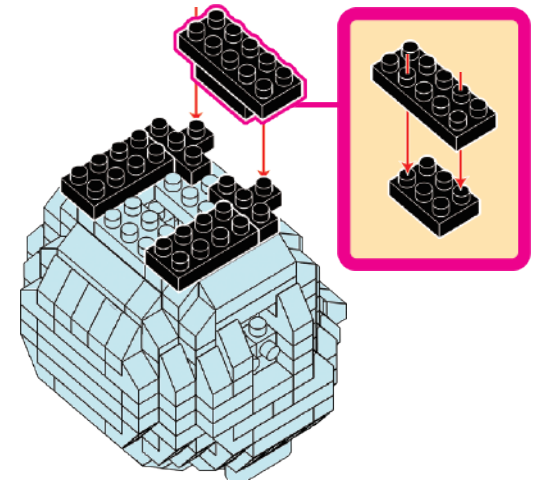
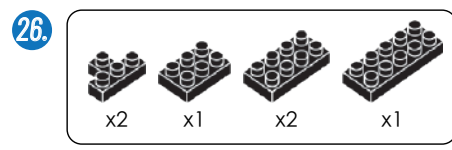
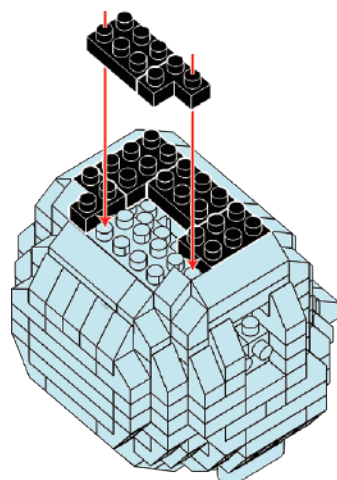
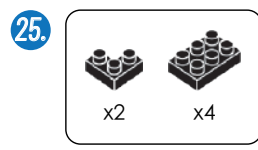
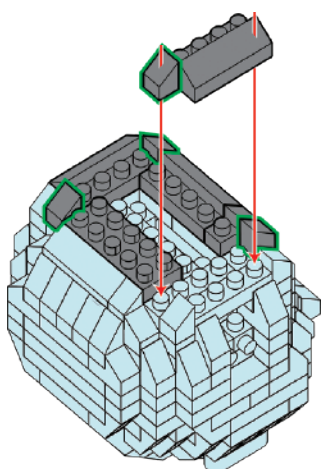
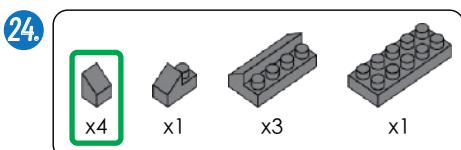
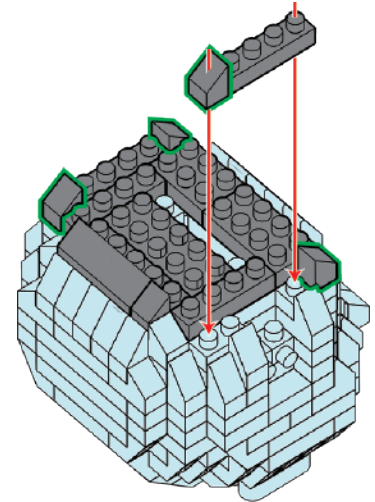
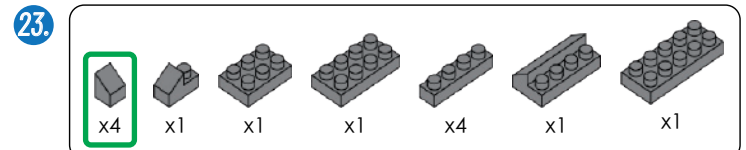
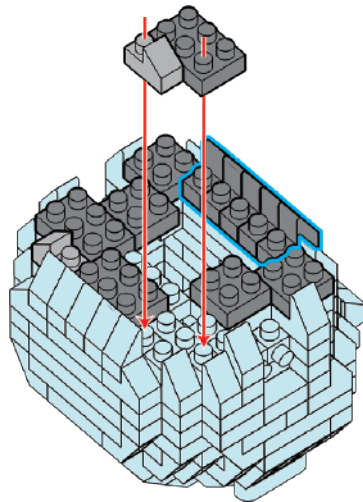
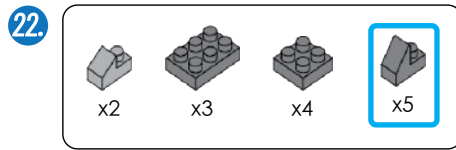
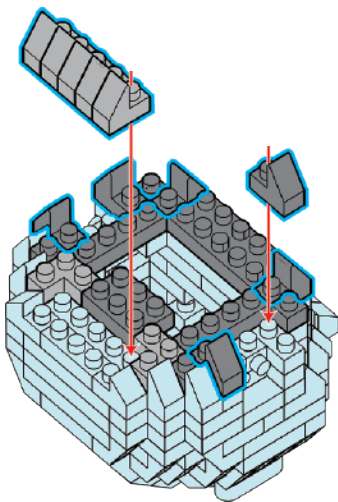
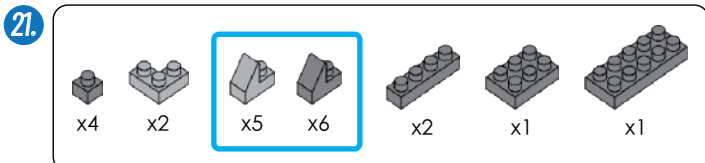
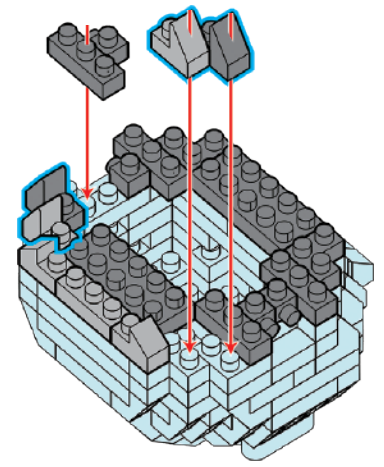
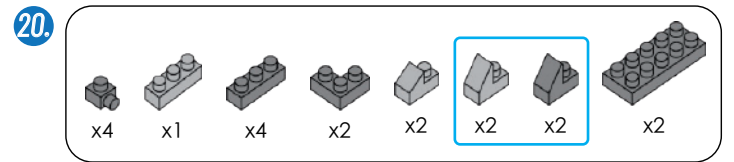
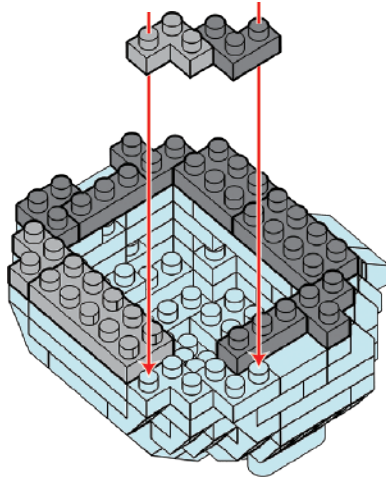
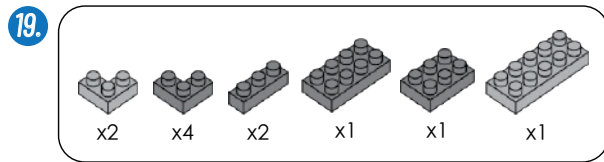
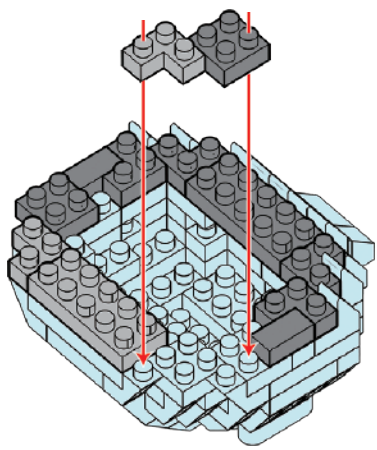
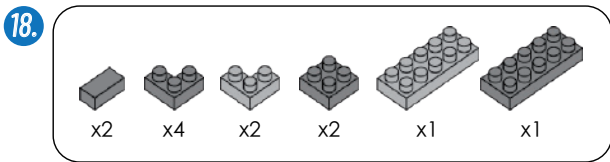
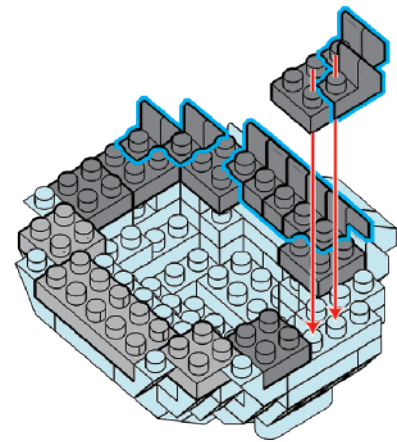
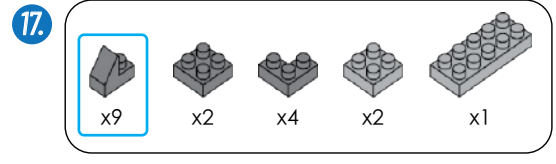
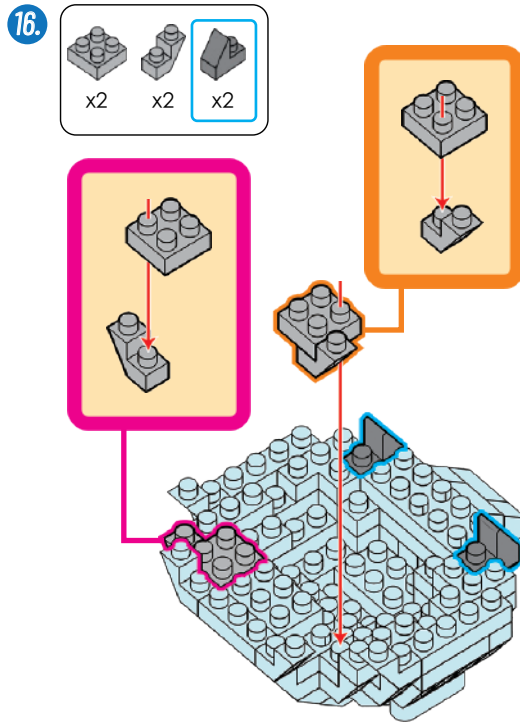
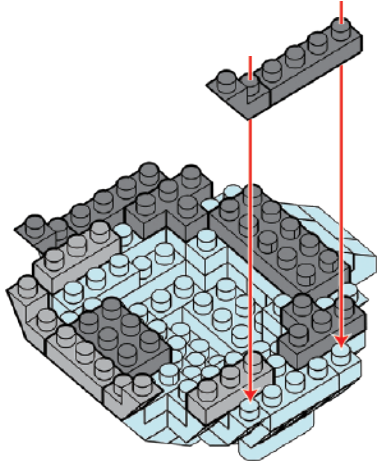
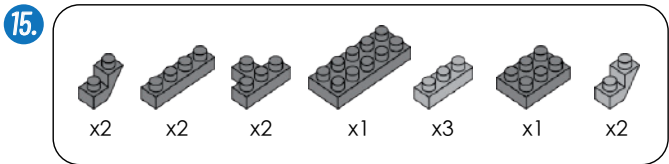

WARNING:
CHOKING HAZARD— Small Parts.
Not for children under 3 years.

WARNING: FOR SAFETY REASONS, REMOVE ALL PACKAGING,
TAGS, LABELS AND PLASTIC FASTENERS BEFORE GIVING
THIS TOY TO YOUR CHILD.

ADULT ASSISTANCE IS RECOMMENDED.
PRODUCT MAY VARY SLIGHTLY FROM IMAGE SHOWN.
PLEASE KEEP PACKAGING FOR FUTURE REFERENCE.



BUILD, DESIGN, DISPLAY

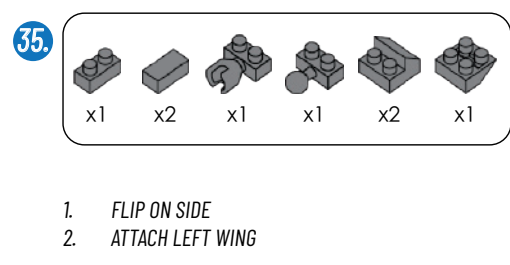
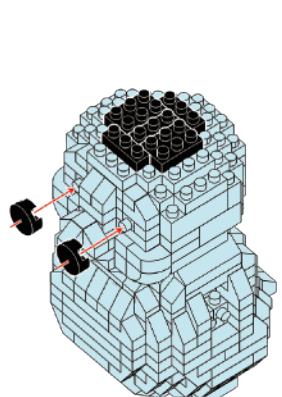
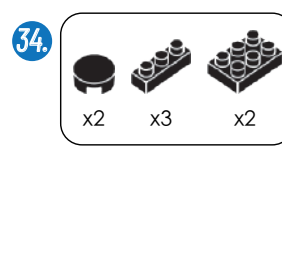
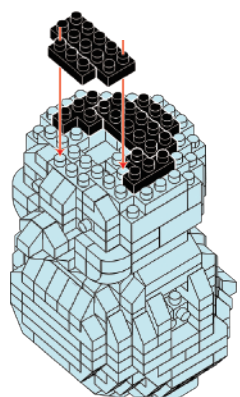
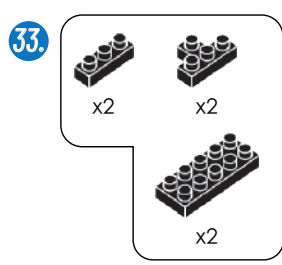
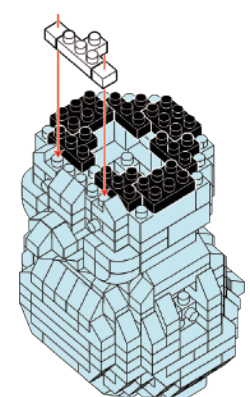
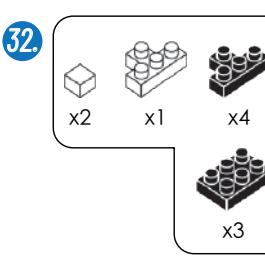
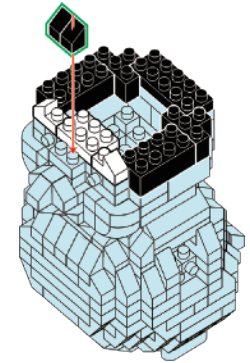
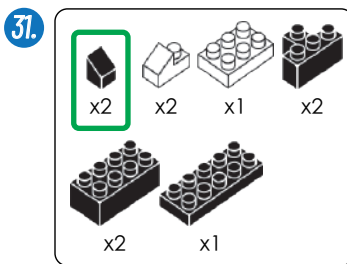
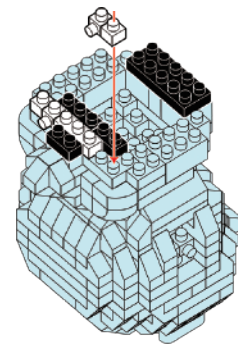
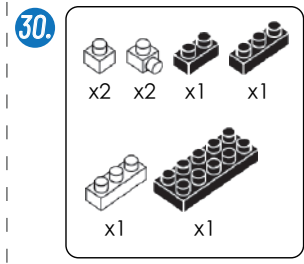
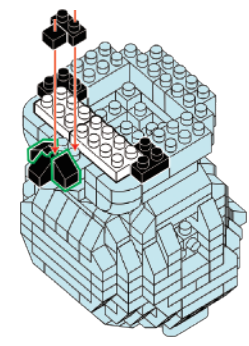
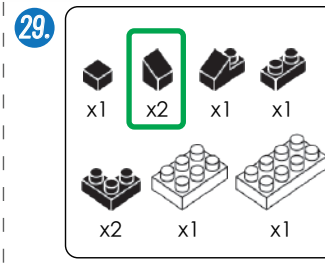
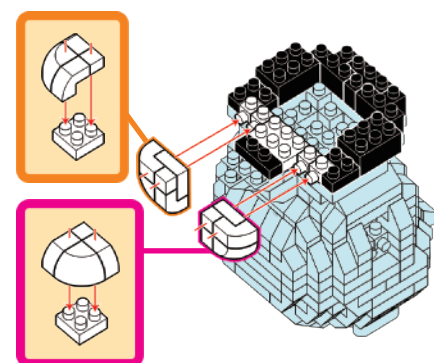
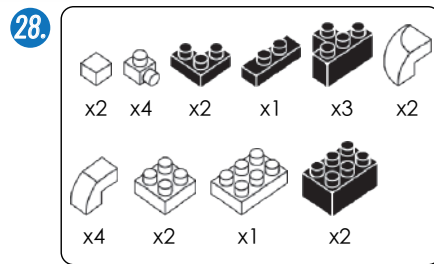
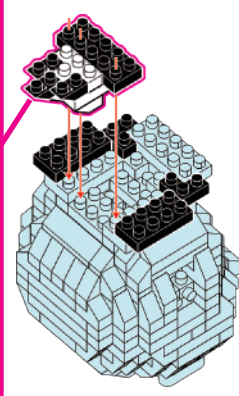
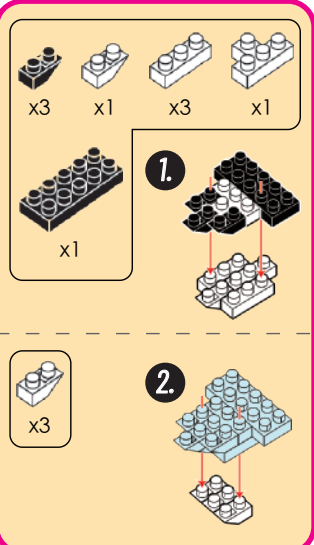
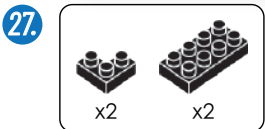

1. FLIP ON SIDE
2. ATTACH LEFT WING

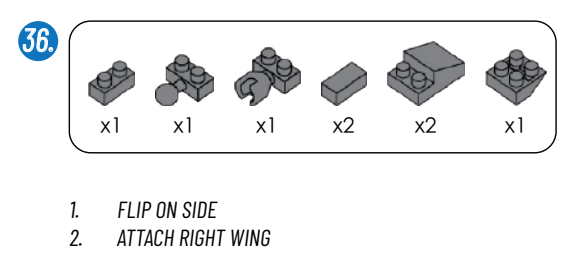
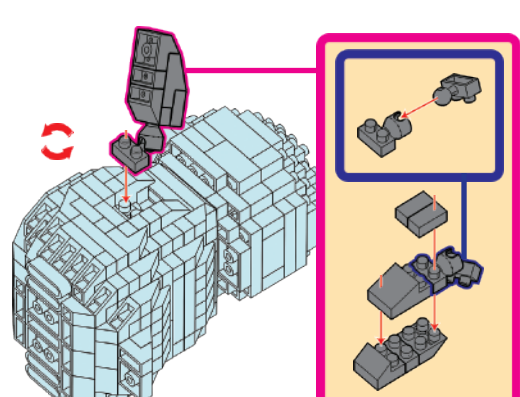

1. FLIP ON SIDE
2. ATTACH RIGHT WING

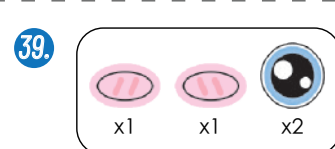
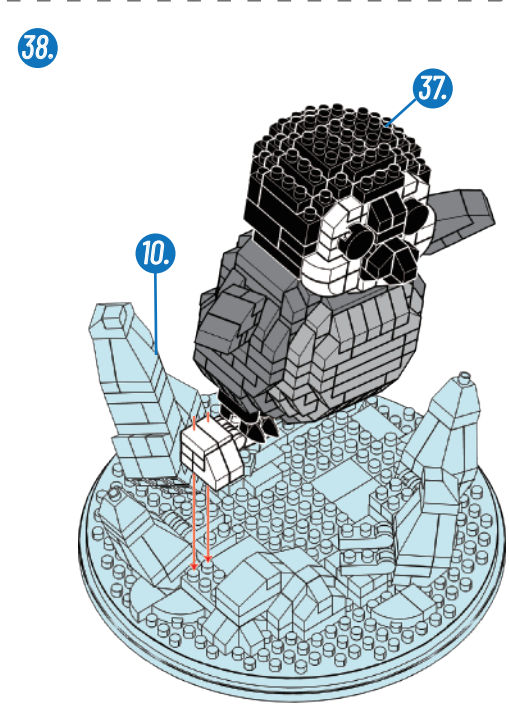
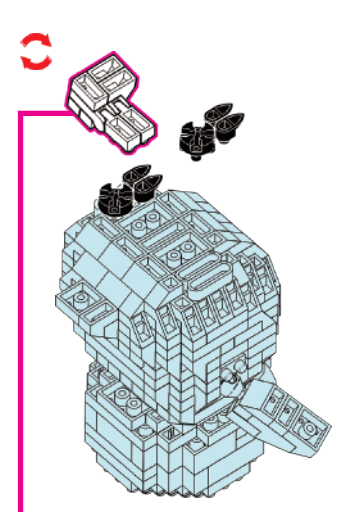
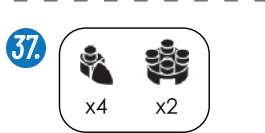
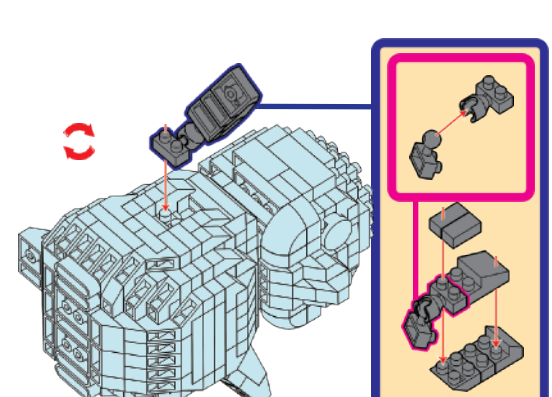

ATTACH THE STICKERS

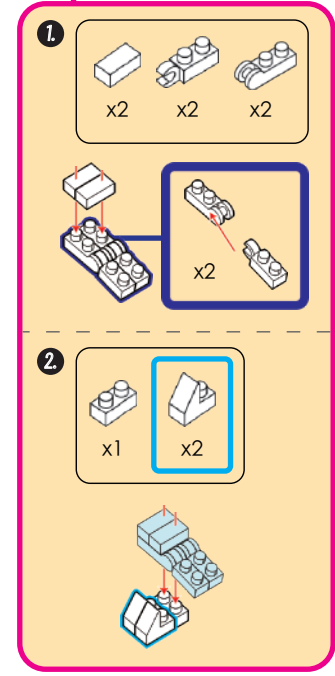
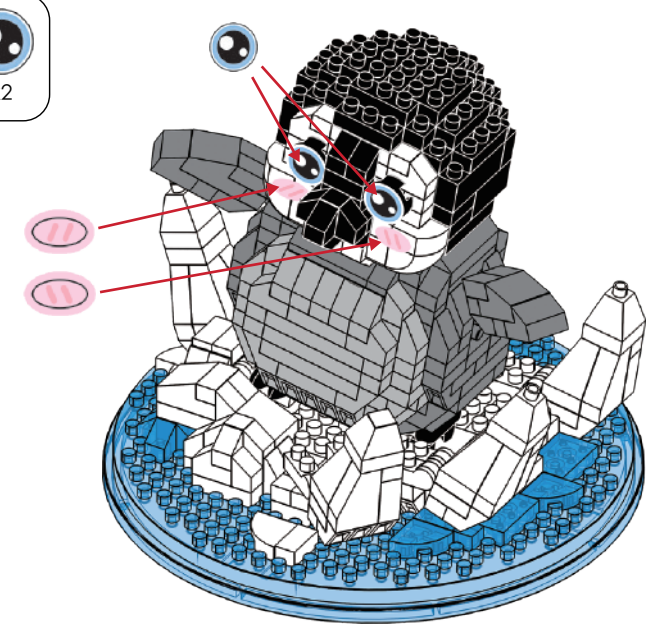

Display your finished build and enjoy your creation!