

BRIK HAUS

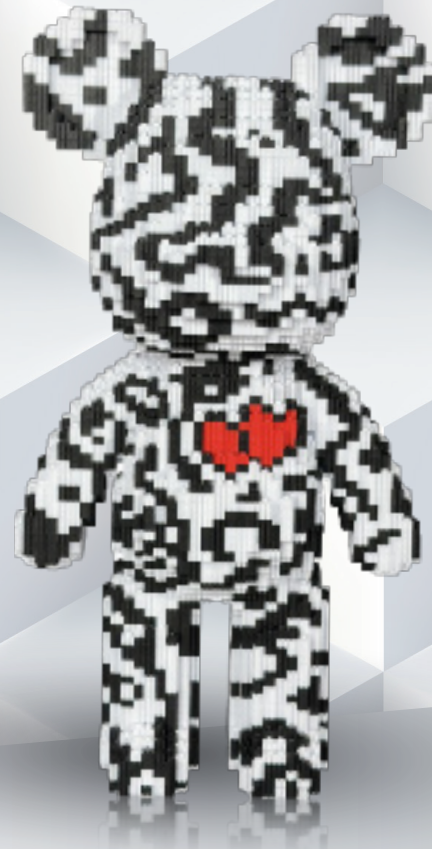

BUILD, DESIGN, DISPLAY
CONSTRUIS. CRÉE. EXPOSE.

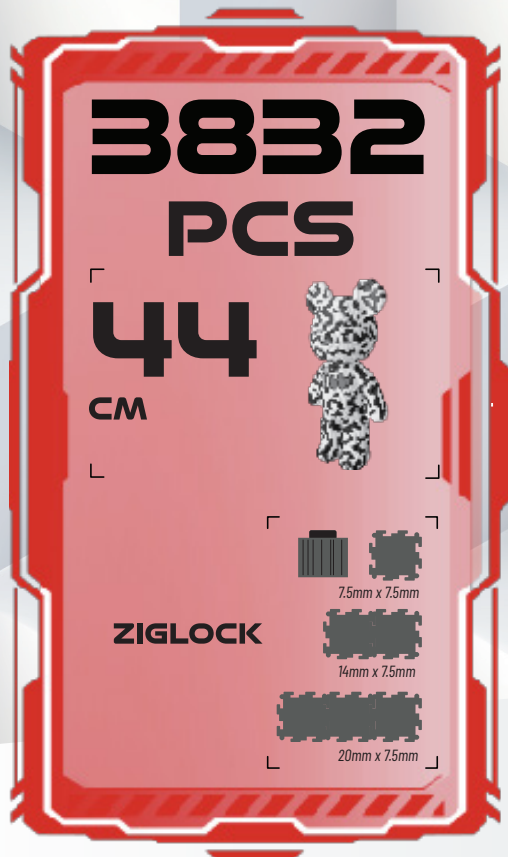

HEARTCODE

ASSEMBLY TIPS / ASTUCES DE MONTAGE

1

DON'T MIX BRICKS.
KEEP SETS SEPARATE.
SORT BY SIZE, THEN
COLOUR.

NE MÉLANGEZ PAS LES
BRIQUES.
GARDEZ CHAQUE
ENSEMBLE SÉPARÉ.
TRIEZ PAR TAILLE, PUIS
PAR COULEUR.

2

HOW TO PUT TOGETHER
THE ZIGLOCK BRICKS:
Align grooves. Slide together.
Press down. Press up.

COMMENT MONTER LES
BRIQUES ZIGLOCK :
Alignez Les Rainures.
Faites Glisser Pour Assembler.
Appuyez vers le bas.
Appuyez vers le haut.

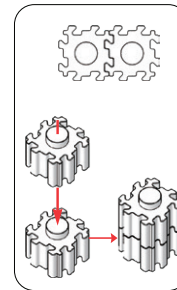
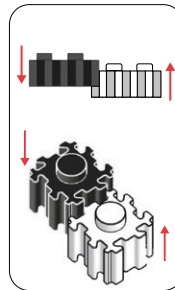

3

LIGHT GREEN = PREVIOUS
STEP.
VERT CLAIR = ÉTAPE PRÉCÉ-
DENTE.

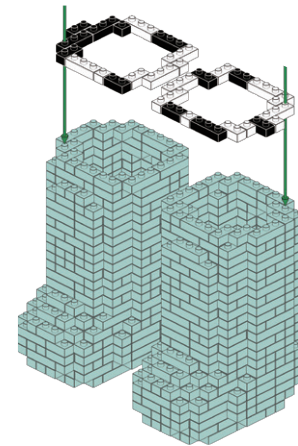

BRIK HAUS

4

ARROWS SHOW
CONNECTIONS.

LES FLÈCHES MONTRENT
LES CONNEXIONS.

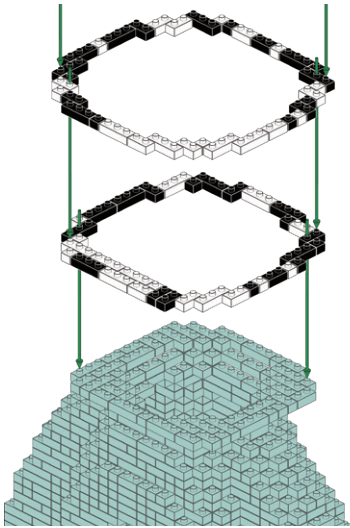

5

TAP WITH HAMMER TO
SECURE.

TAPOTEZ AVEC LE MARTEAU
POUR FIXER.

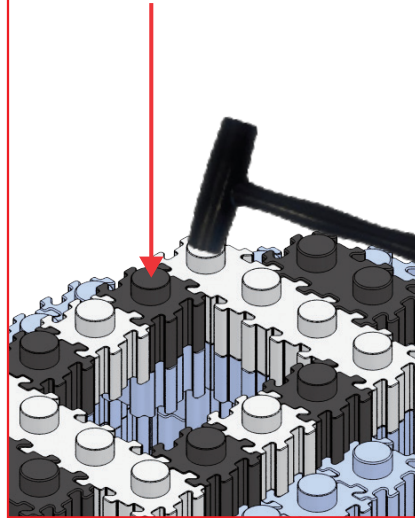

6

DON'T GIVE UP!
*It may take time - keep going.
Scan QR code for tips.*

N'ABANDONNEZ PAS !
*Cela peut prendre
du temps - continuez.
Scannez le code QR
pour des conseils.*

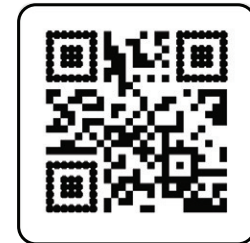

ADULT ASSISTANCE IS RECOMMENDED. PRODUCT MAY VARY SLIGHTLY FROM IMAGE SHOWN.
LA SUPERVISION D'UN ADULTE EST RECOMMANDÉE. LE PRODUIT PEUT VARIER LÉGÈREMENT PAR RAPPORT À L'IMAGE ILLUSTRÉE.

3

1

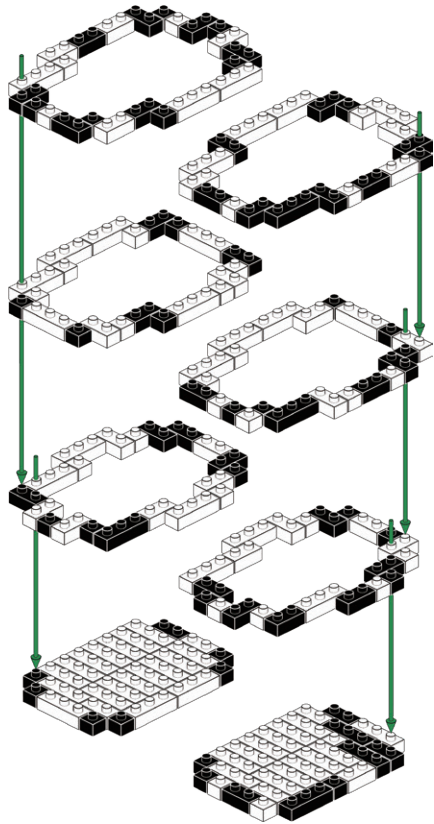
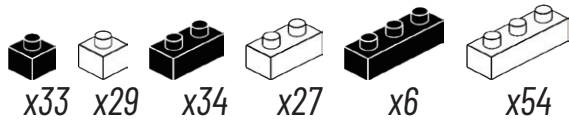

2

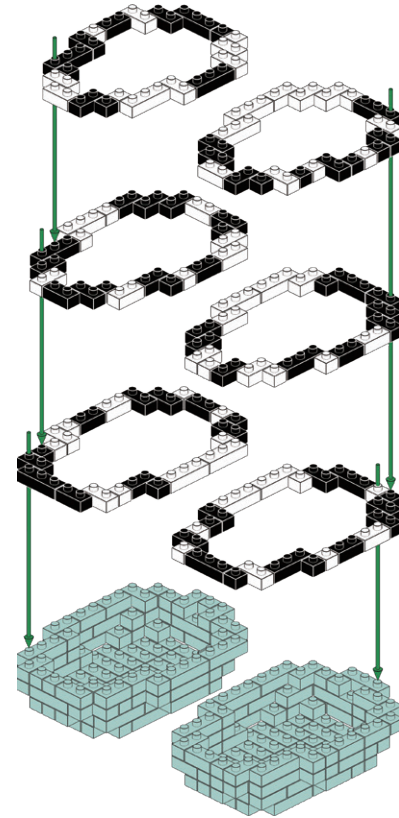
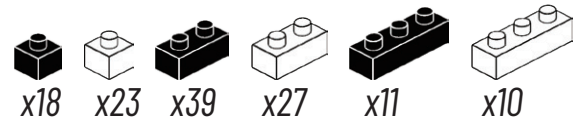

4

3

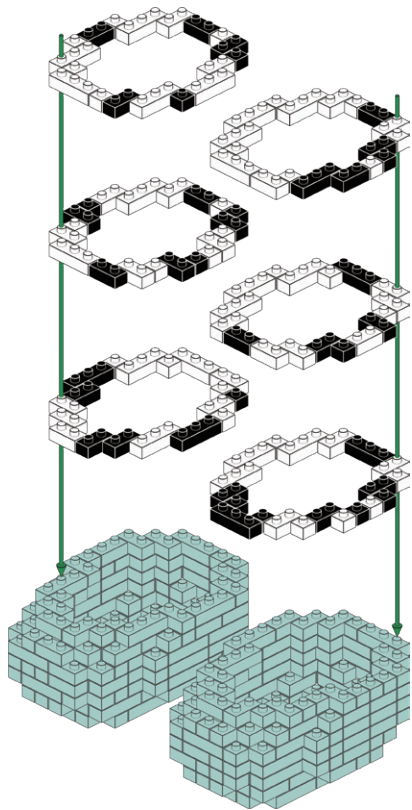
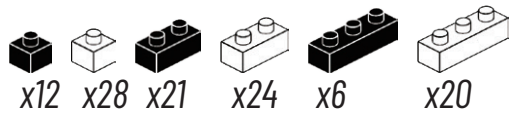

4

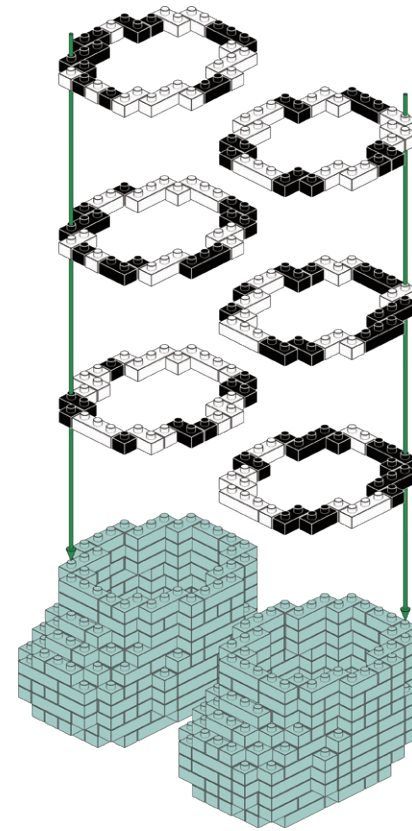
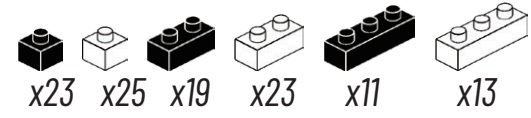

5

5

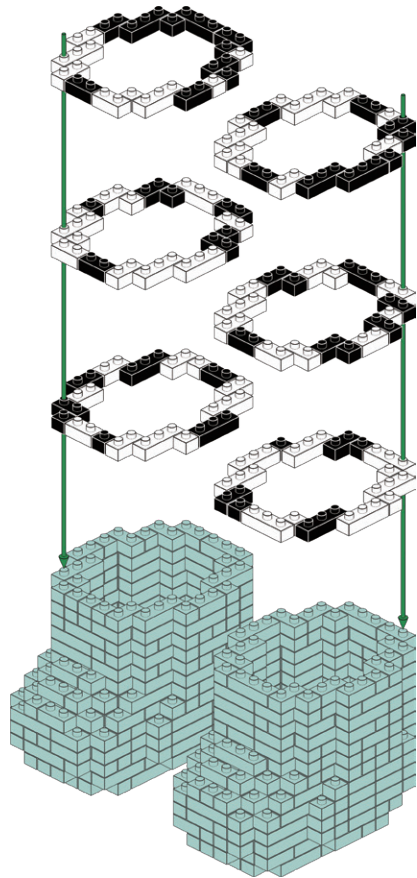
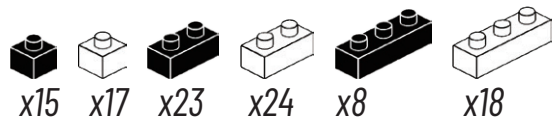

6

6

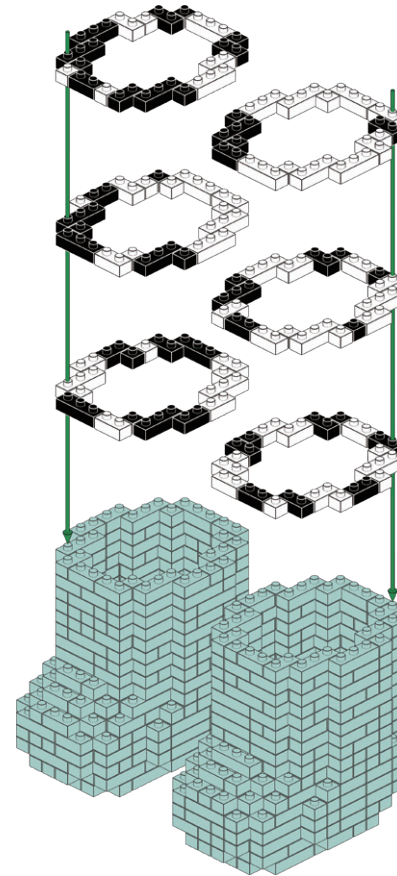
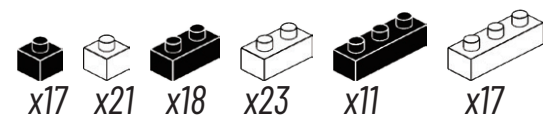

7

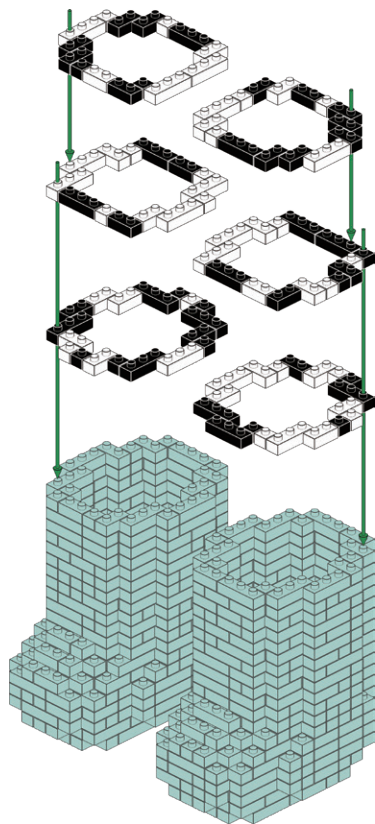
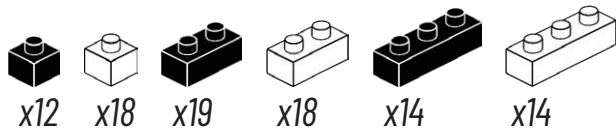



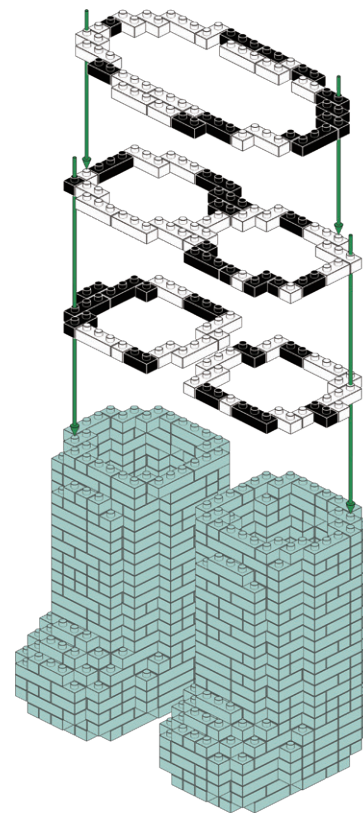
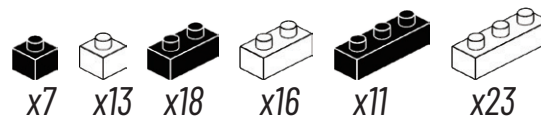

8



7



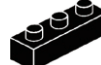
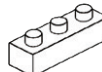

9

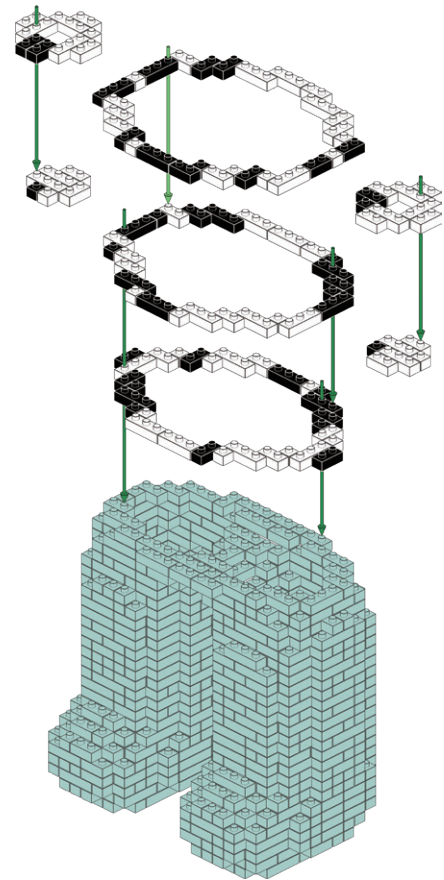
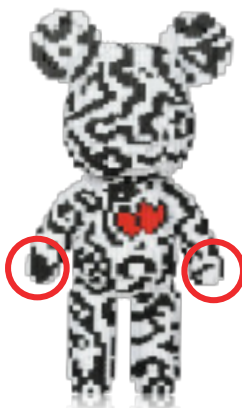
- 
x12
- 
x19
- 
x18
- 
x29
- 
x12
- 
x25

ARMS -
START
BRAS -
DÉBUT DU MONTAGE

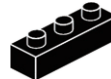
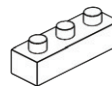

10

- 
x16
- 
x26
- 
x29
- 
x27
- 
x15
- 
x37

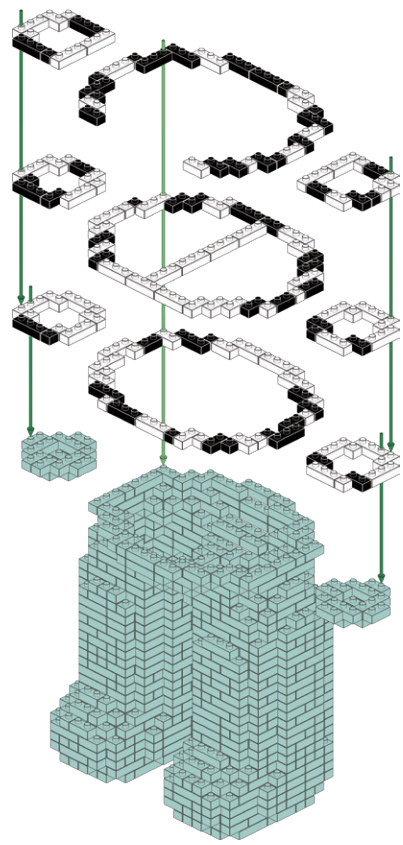

8



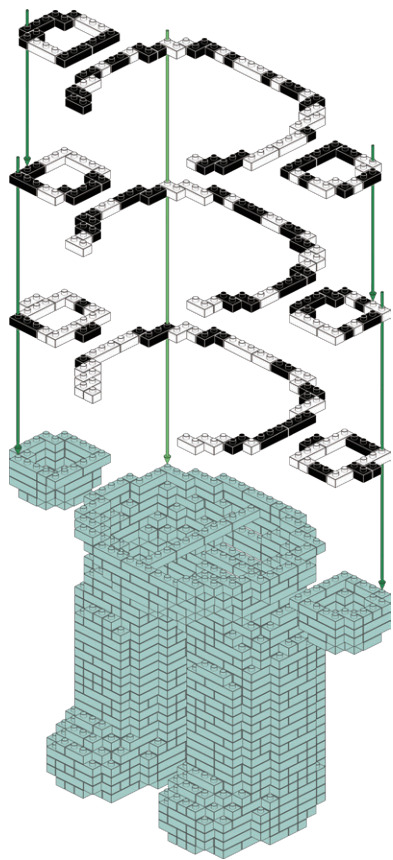
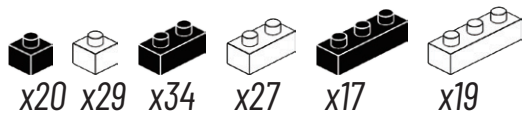

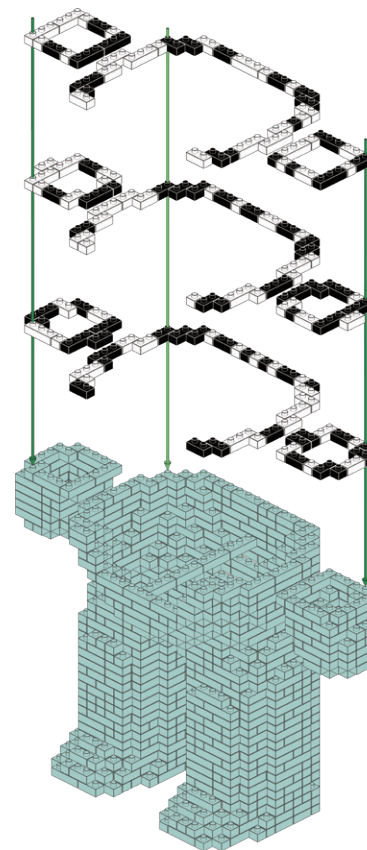
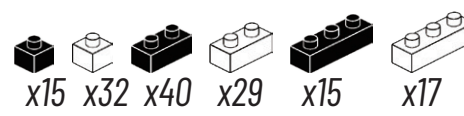

11



12



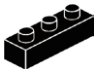





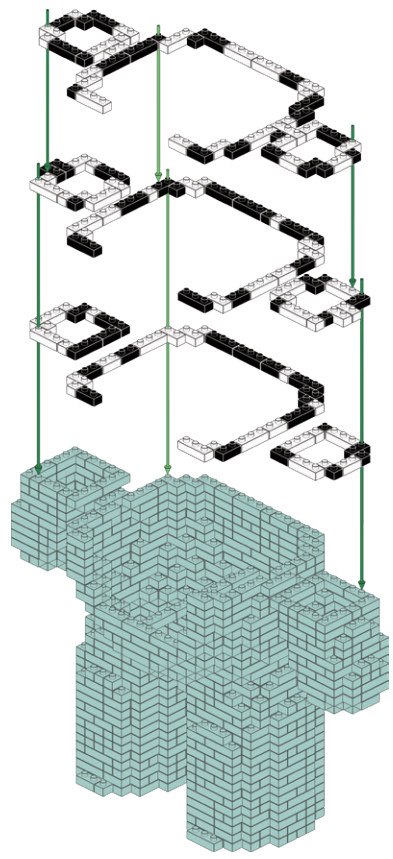

13

-  x19
-  x26
-  x24
-  x29
-  x20
-  x22

ARMS - CONNECT
FIXATION DES BRAS



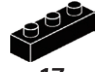



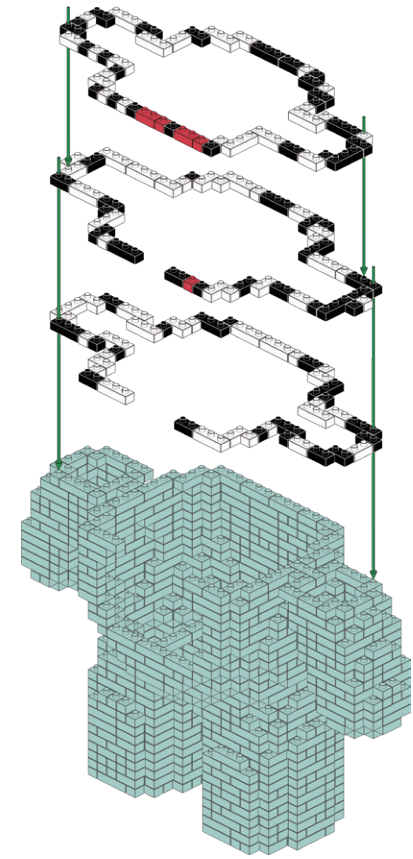



14

-  x25
-  x29
-  x3
-  x25
-  x23
-  x2
-  x13
-  x21







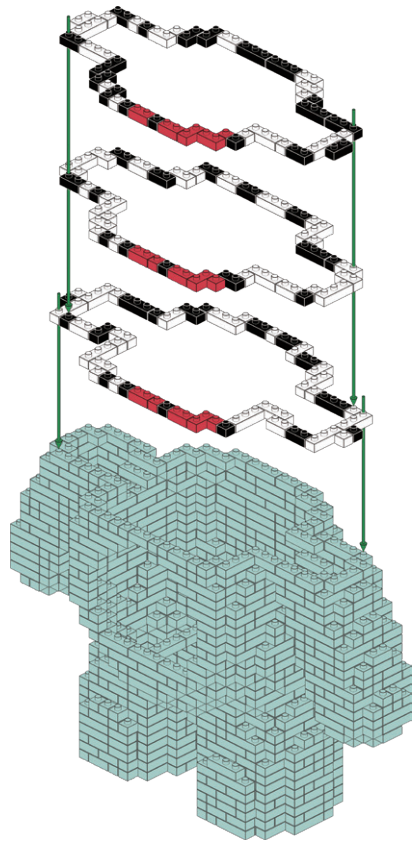



15

-  x20
-  x30
-  x5
-  x21
-  x10
-  x20
-  x8
-  x19





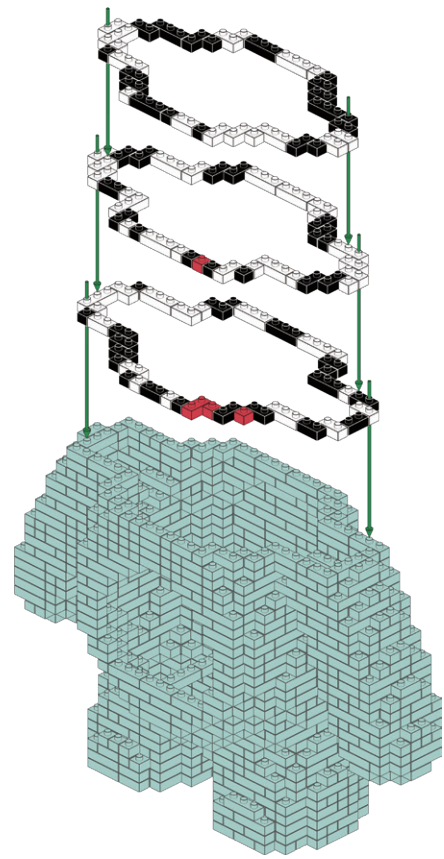

16

-  x19
-  x18
-  x3
-  x29
-  x1
-  x21
-  x6
-  x16





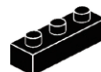
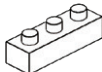

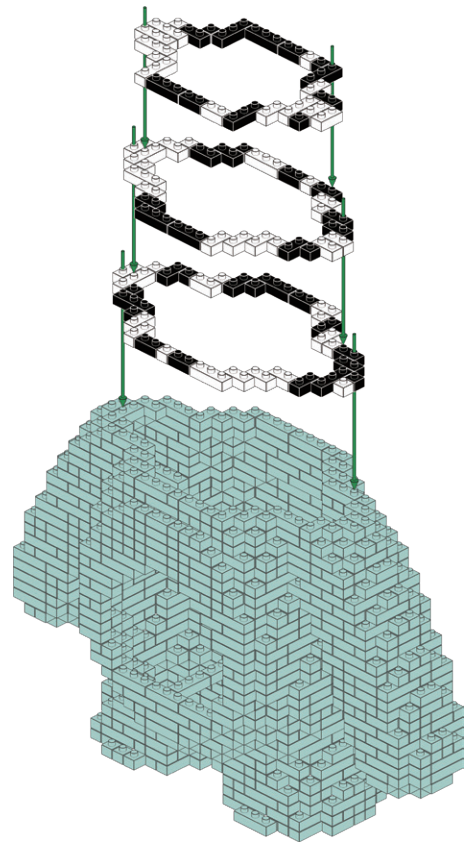
17

-  x10
-  x14
-  x21
-  x23
-  x10
-  x10

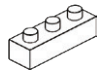

18

-  x9
-  x14
-  x20
-  x16
-  x9
-  x18

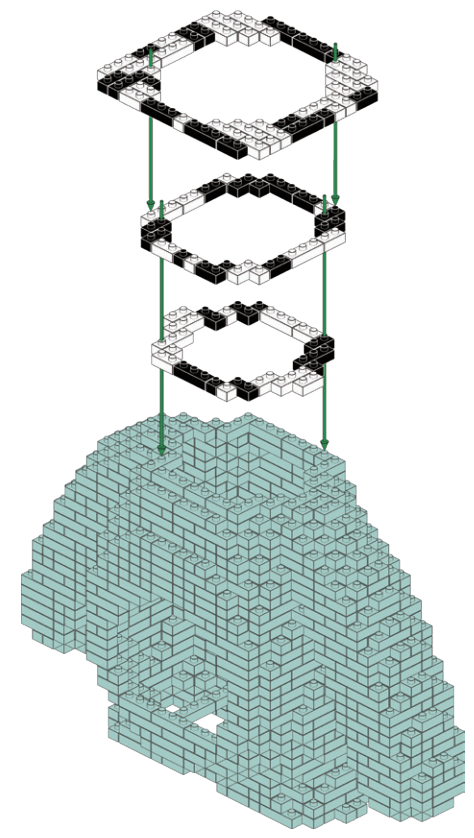

19

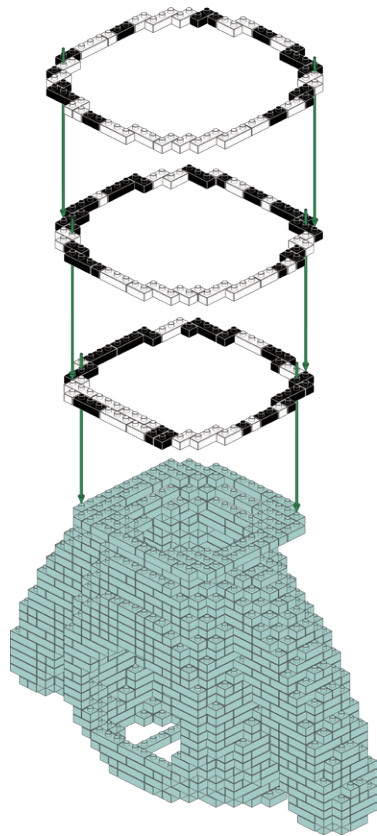
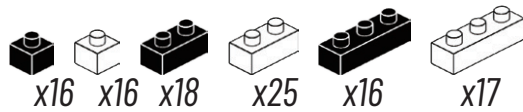

20

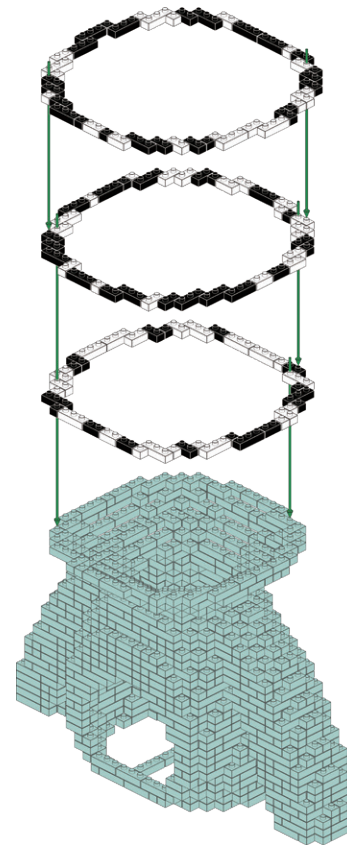
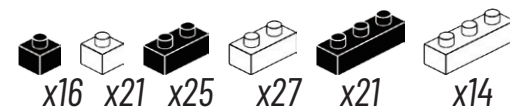

13

21

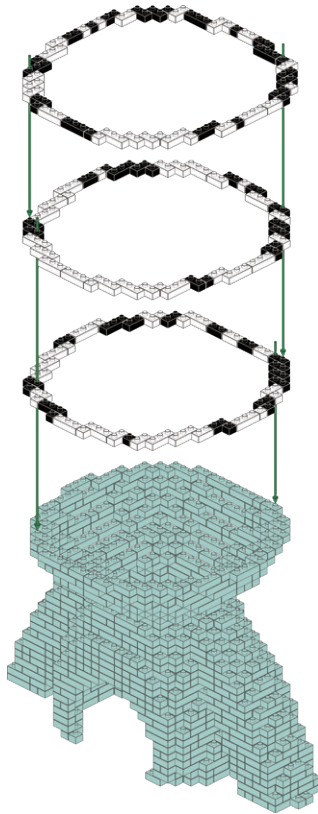
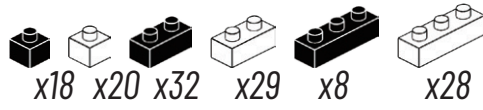

22

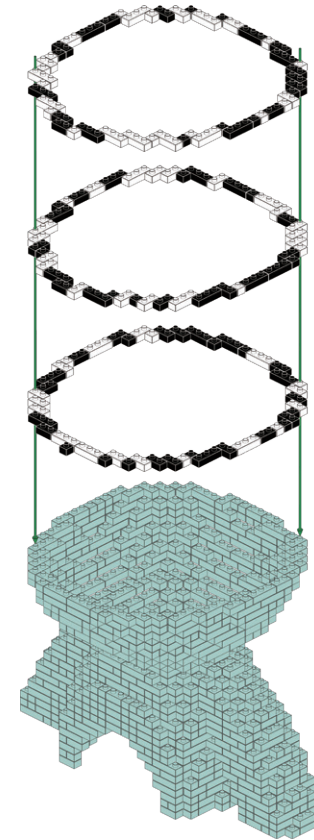
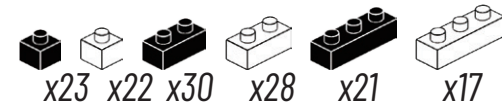

23

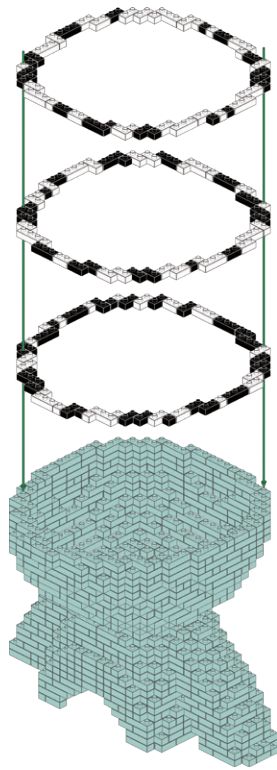
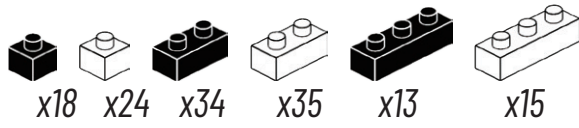

24

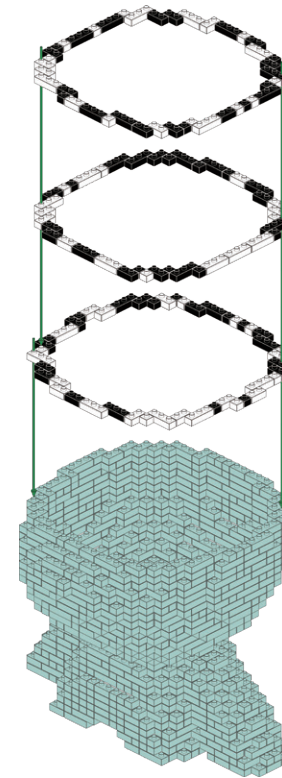
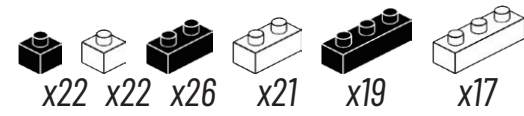



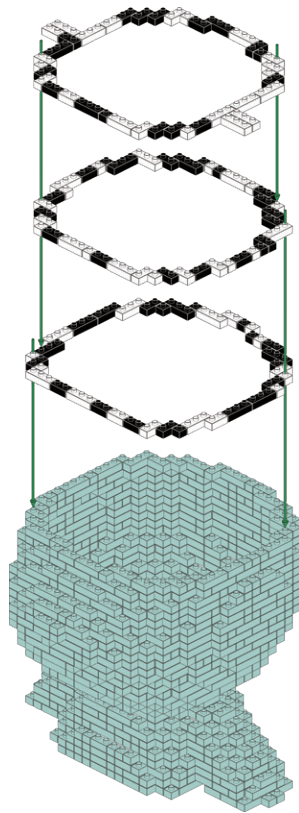
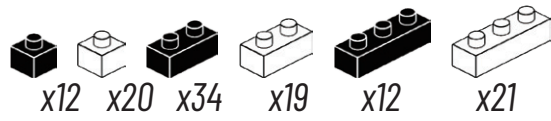

25

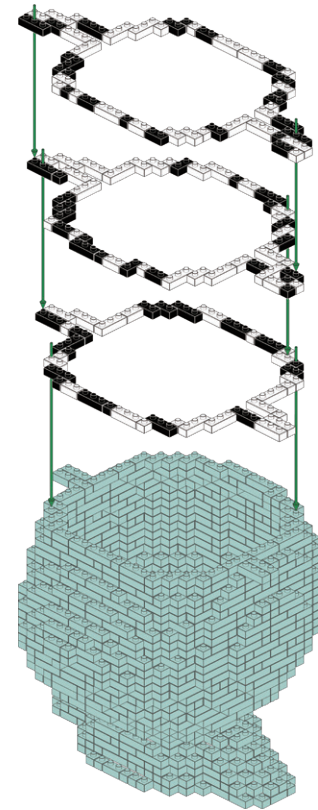
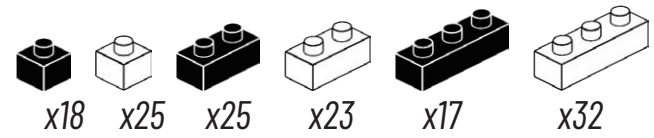

26





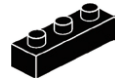
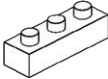

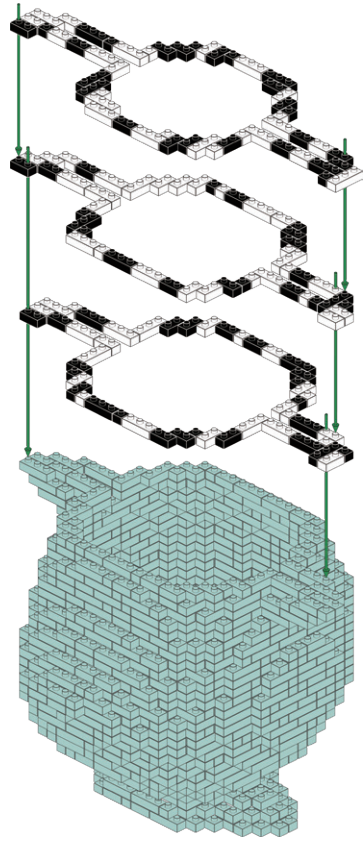
27

- 
x19
- 
x18
- 
x37
- 
x30
- 
x14
- 
x29

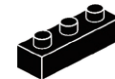
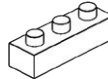

28

- 
x14
- 
x17
- 
x22
- 
x15
- 
x27
- 
x44

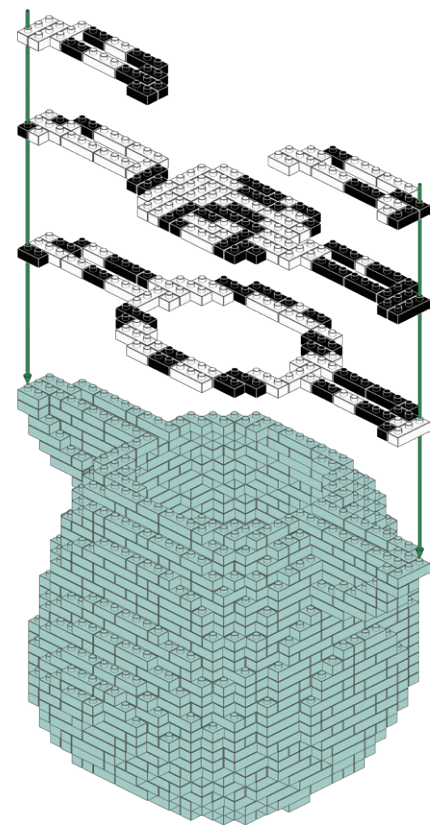

29

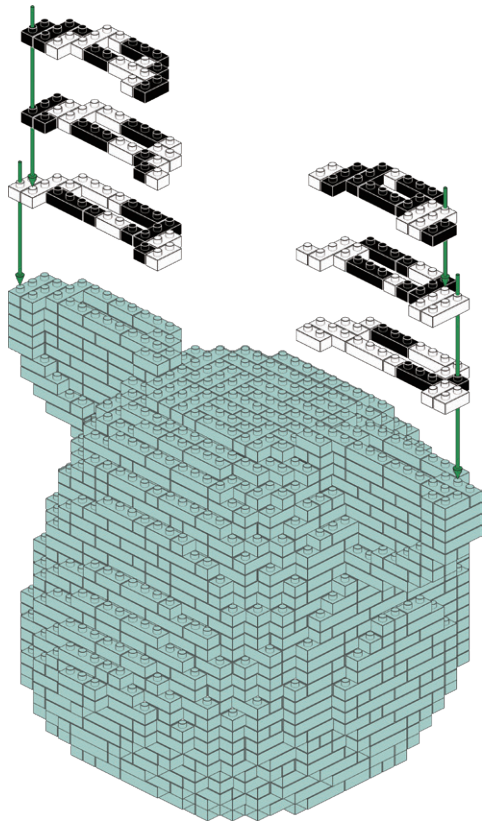
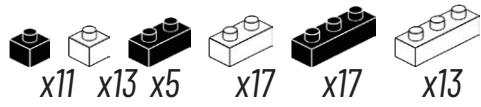

30

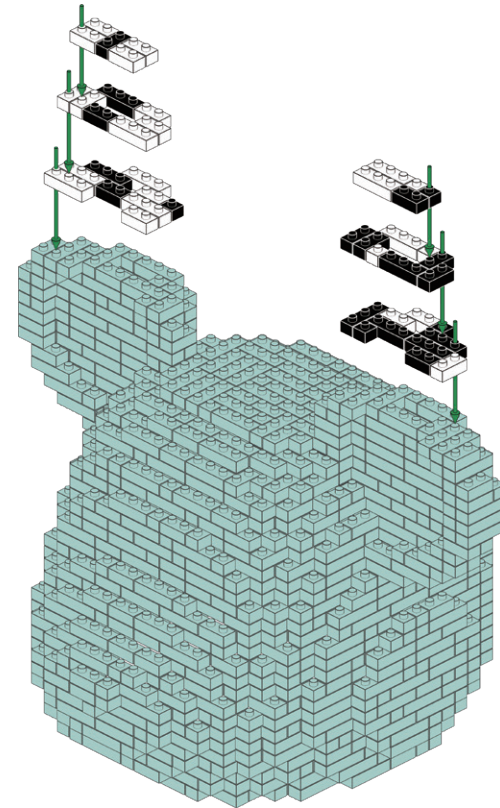
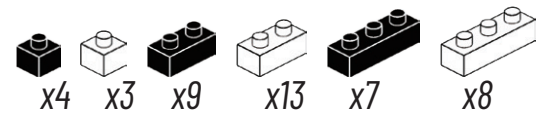

18

31

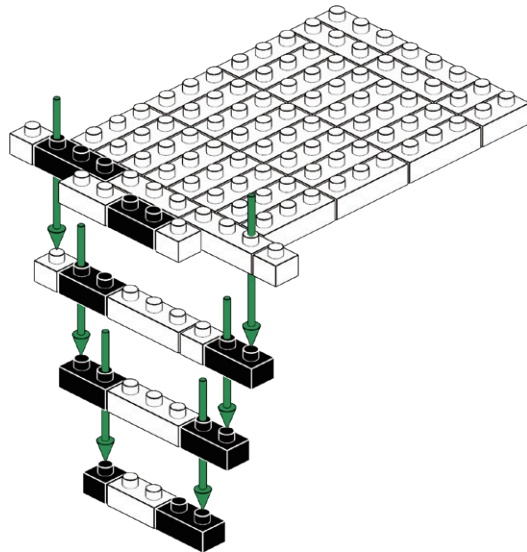
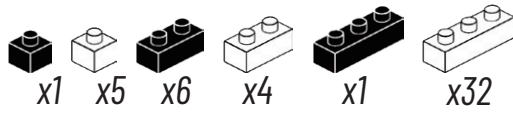

32

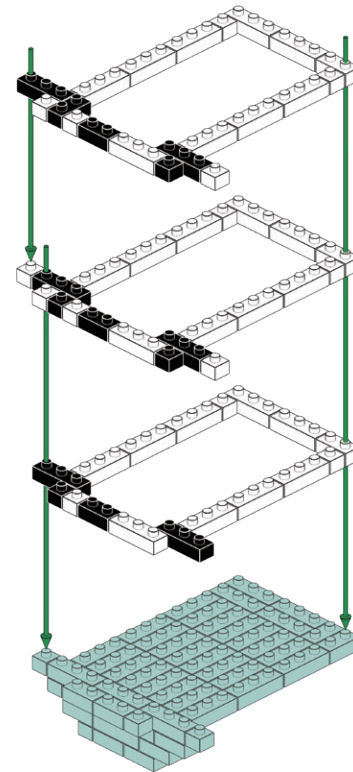
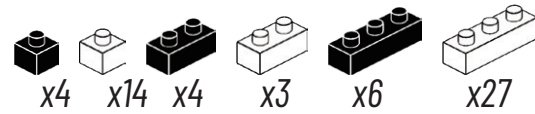

33

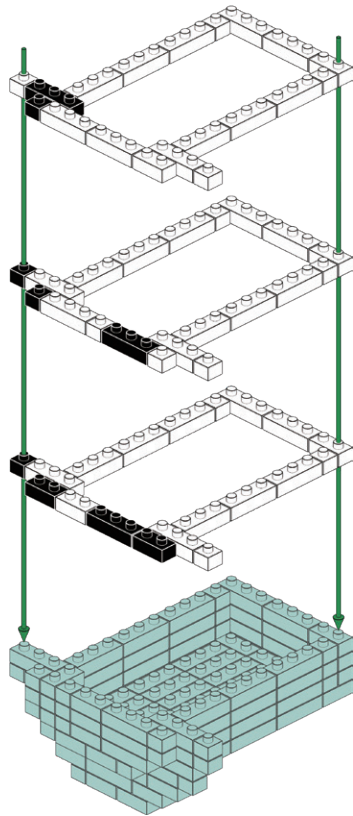
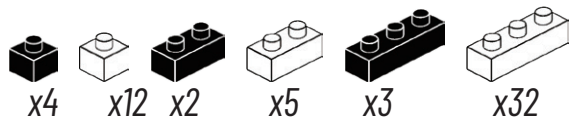

34

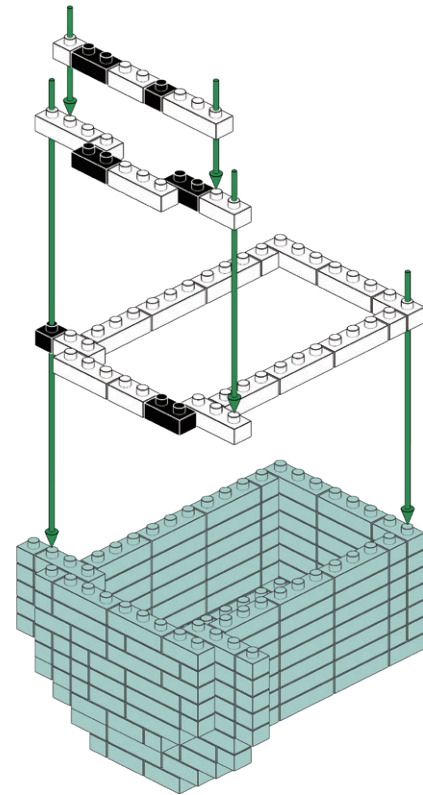
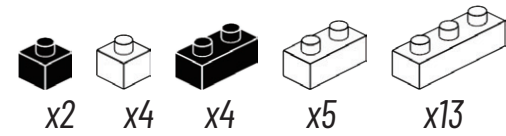

20

35

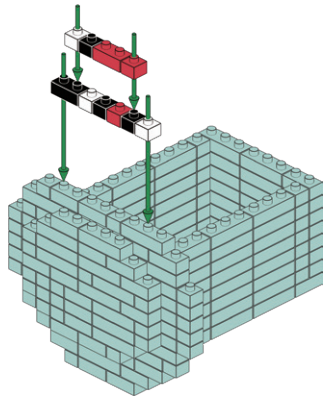
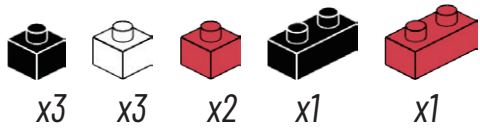

Secret Storage!

Compartment Secret!

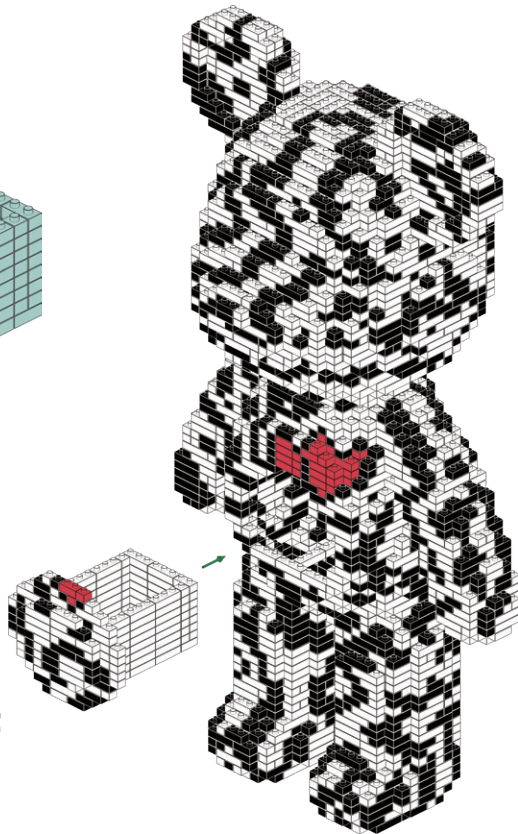

 **WARNING:**
CHOKING HAZARD— Small Parts.
Not for children under 3 years.

 **ATTENTION:**
RISQUE D'ÉTOUFFEMENT— Petites pièces.
Ne convient pas aux enfants de moins de 3 ans.



© 2026 Good Idea Global
Suite 1(A)/207-209 Warrigal Road,
Hughesdale, Victoria, 3166
Melbourne, Australia
www.goodideaglobal.com

IMPORTED BY/PAR:
GENCO International Ltd.
DBA Kroeger Marketing
727 Tapscott Road,
Toronto, Ontario,
M1X 1A2, Canada

FOR SAFETY REASONS, REMOVE ALL PACKAGING,
TAGS, LABELS AND PLASTIC FASTENERS BEFORE GIVING
THIS TOY TO YOUR CHILD.

POUR DES RAISONS DE SÉCURITÉ, RETIREZ TOUS
LES ÉLÉMENTS D'EMBALLAGE, ÉTIQUETTES ET ATTACHES
EN PLASTIQUE AVANT DE DONNER CE JOUET À UN ENFANT.

ADULT ASSISTANCE IS RECOMMENDED.
PRODUCT MAY VARY SLIGHTLY FROM IMAGE SHOWN.
PLEASE KEEP PACKAGING FOR FUTURE REFERENCE.

L'ASSISTANCE D'UN ADULTE PEUT ÊTRE REQUISE.
LE PRODUIT PEUT VARIER LÉGÈREMENT DE L'IMAGE PRÉSENTÉE.
VEUILLEZ CONSERVER L'EMBALLAGE POUR RÉFÉRENCE ULTÉRIEURE.

GS-FNO.5555

**MADE IN CHINA
FABRIQUÉ EN CHINE**