

BUILD, DESIGN, DISPLAY

PARTS LIST

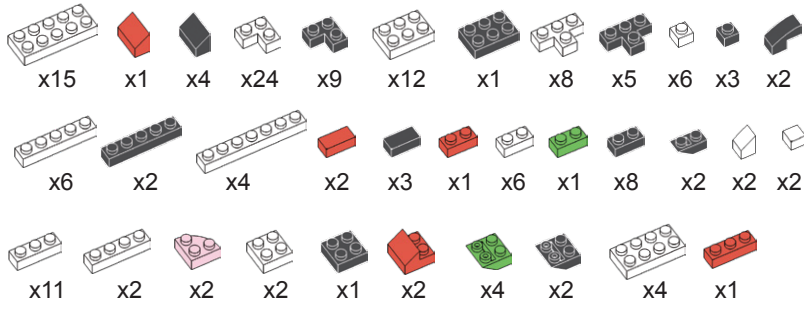

160 PCS



1.

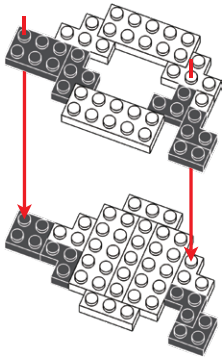
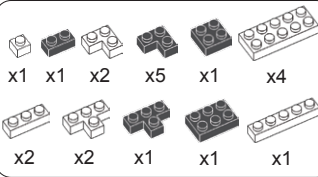

2.

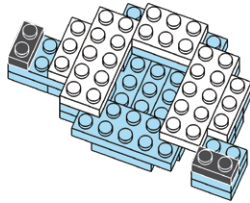
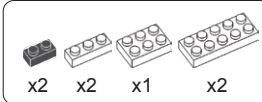

3.

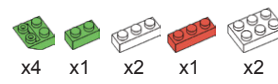

(STACK 'STEP B' ON TOP OF 'STEP A' AND THEN PLACE IT ON THE PREVIOUS BUILD)

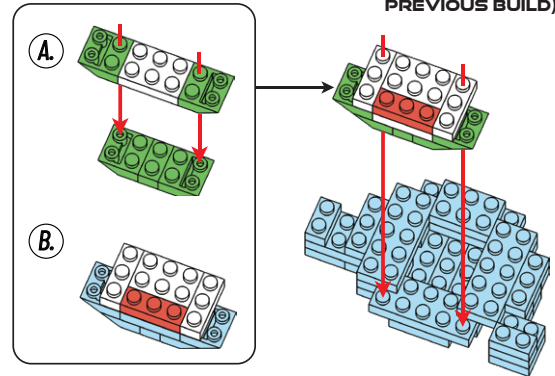

4.

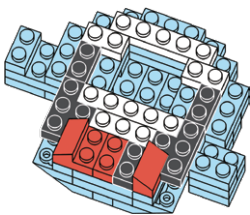
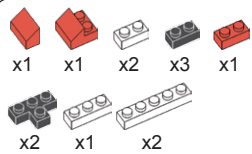

5.

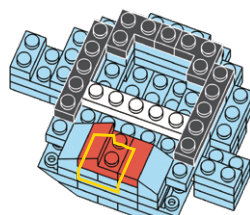
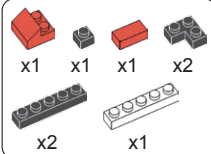

6.

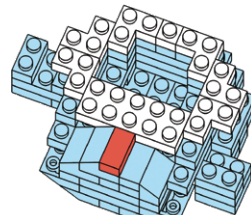
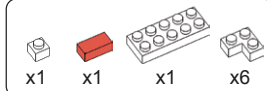

7.

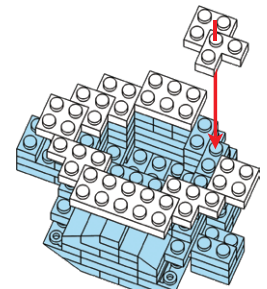
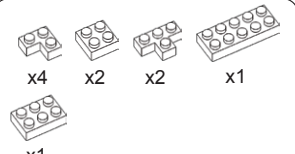

8.

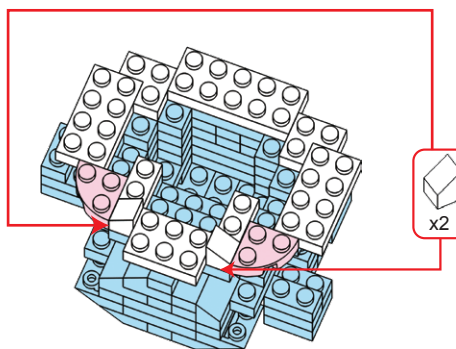
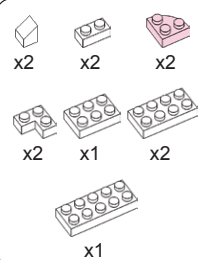

9.

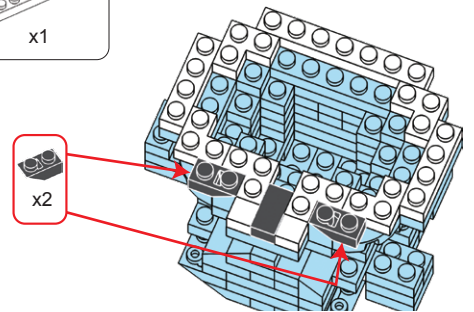
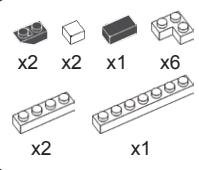

BUILD, DESIGN, DISPLAY

10.

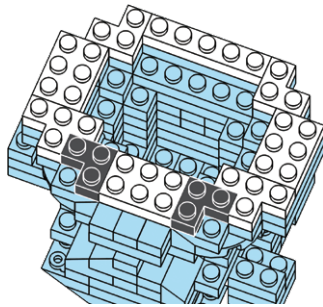
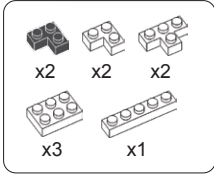

11.

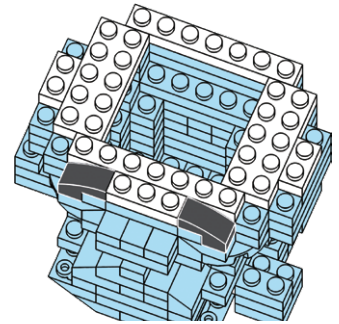
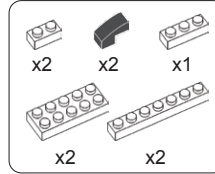

10.

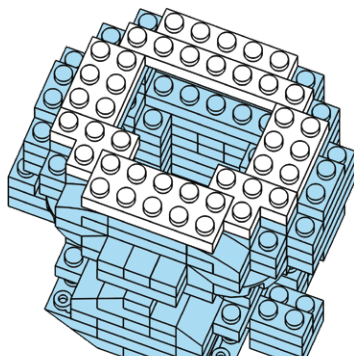
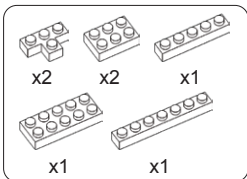

11.

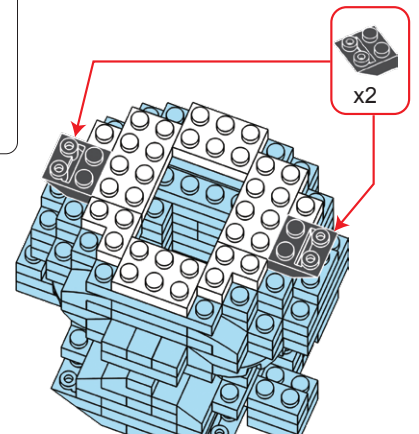
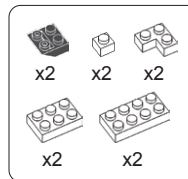

12.

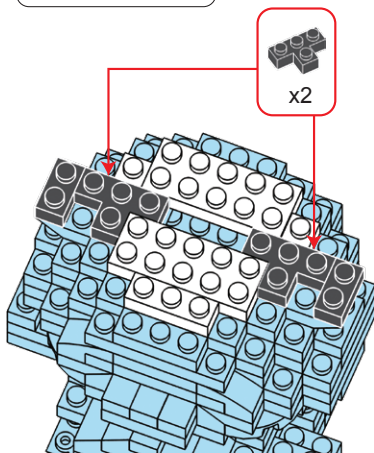
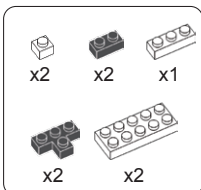

12.

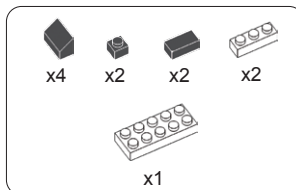

(FLAT BLACK PIECES GO ON TOP)

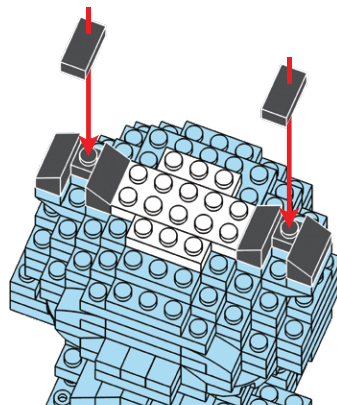

Display your finished build and enjoy your creation!



WARNING:

CHOKING HAZARD— Small Parts.
Not for children under 3 years.



WARNING! FOR SAFETY REASONS, REMOVE ALL PACKAGING, TAGS, LABELS AND PLASTIC FASTENERS BEFORE GIVING THIS TO A CHILD.

PLEASE KEEP THE PACKAGING FOR FUTURE REFERENCE. PRODUCT MAY VARY SLIGHTLY FROM IMAGE SHOWN. ADULT ASSISTANCE IS RECOMMENDED.

MADE IN CHINA



© 2026 Good Idea Global
Suit 1 (A)/207-209 Warrigal Road,
Hughesdale, Victoria, 3166
Melbourne, Australia
www.goodideaglobal.com