

BUILD, DESIGN, DISPLAY

## PARTS LIST

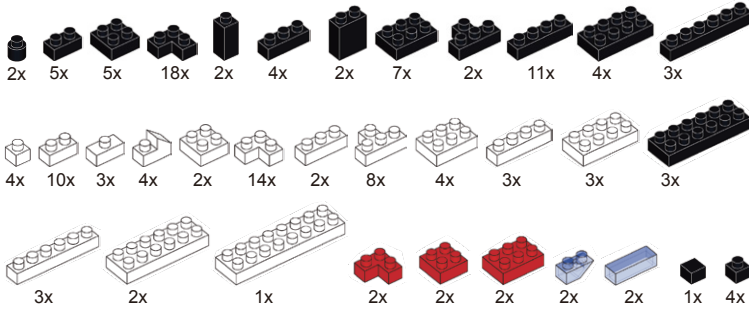

**146 PCS**

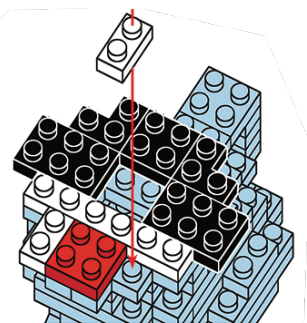
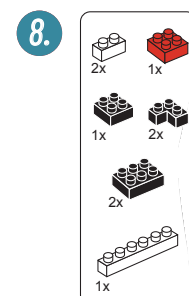
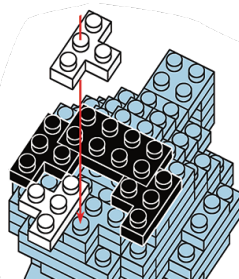
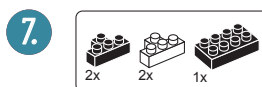
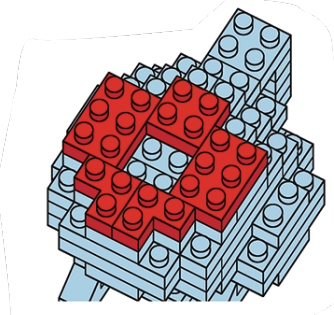
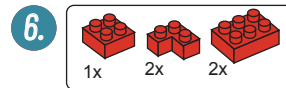
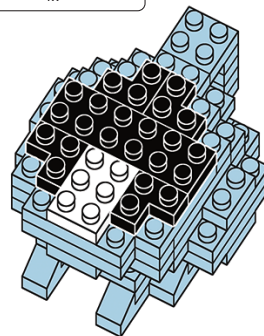
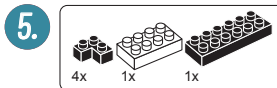
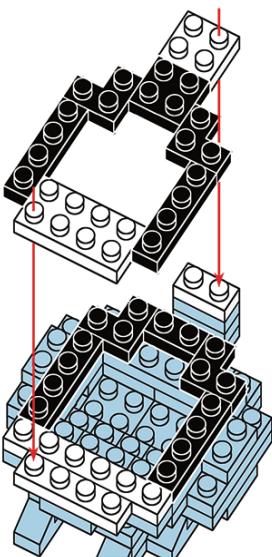
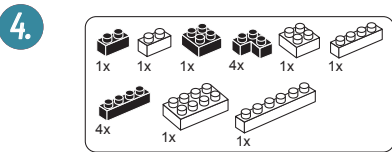
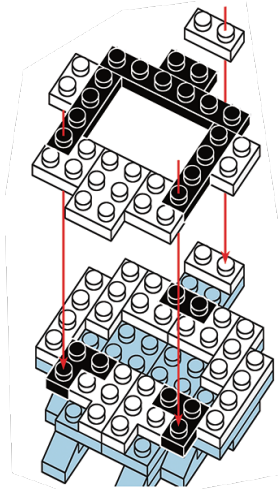
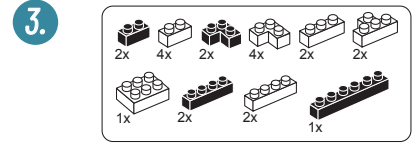
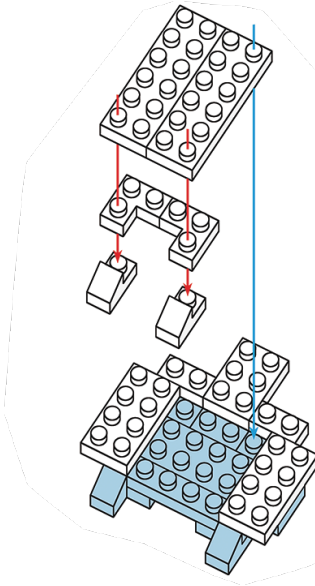
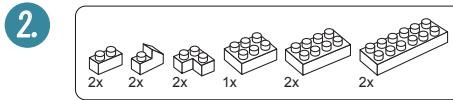
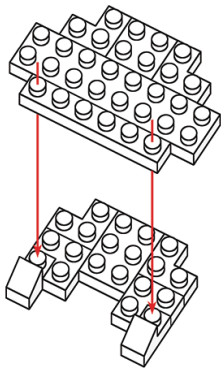
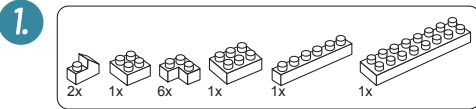

BUILD, DESIGN, DISPLAY

9.

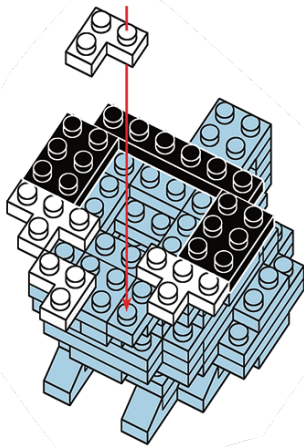
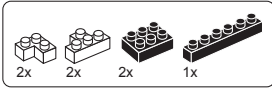

10.

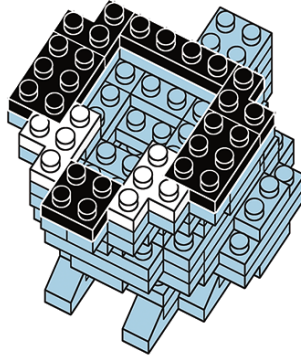
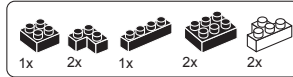

11.

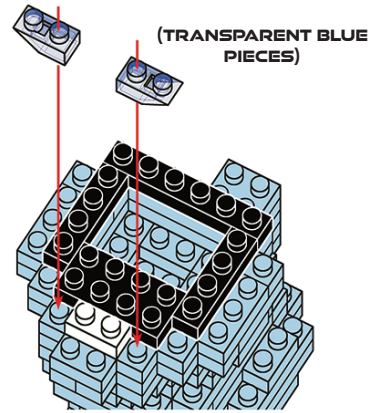
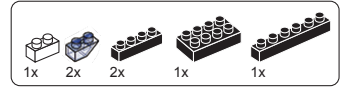

12.

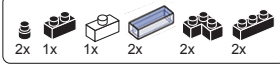

(TRANSPARENT BLUE PIECES)

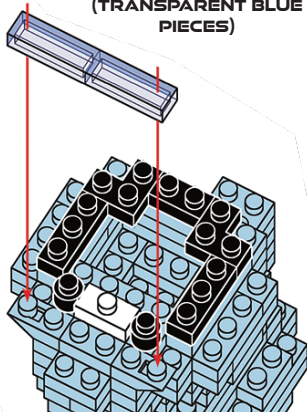

13.

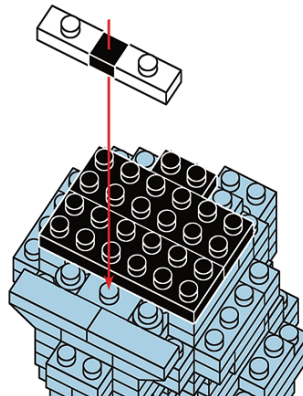
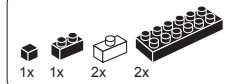

14.

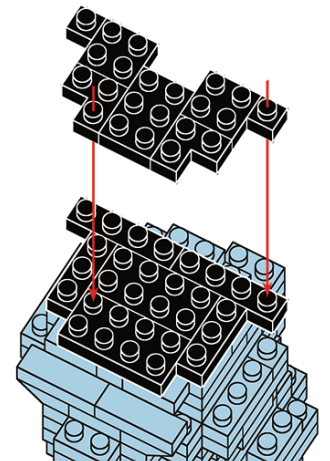
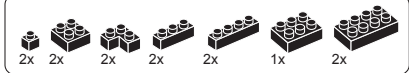

15.

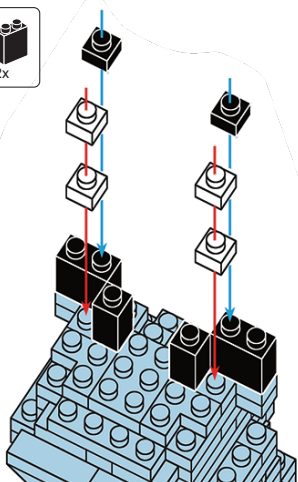

Display your finished build and enjoy your creation!

**WARNING:**  
CHOKING HAZARD— Small Parts.  
Not for children under 3 years.



**WARNING!** FOR SAFETY REASONS, REMOVE ALL PACKAGING, TAGS, LABELS AND PLASTIC FASTENERS BEFORE GIVING THIS TO A CHILD.

PLEASE KEEP THE PACKAGING FOR FUTURE REFERENCE. PRODUCT MAY VARY SLIGHTLY FROM IMAGE SHOWN. ADULT ASSISTANCE IS RECOMMENDED.

MADE IN CHINA



© 2026 Good Idea Global  
Suit 1 (A)/207-209 Warrigal Road,  
Hughesdale, Victoria, 3166  
Melbourne, Australia  
www.goodideaglobal.com